

HILTI

PT 10

Bedienungsanleitung

de

Operating instructions

en

Mode d'emploi

fr

Bruksanvisning

sv

取扱説明書

ja



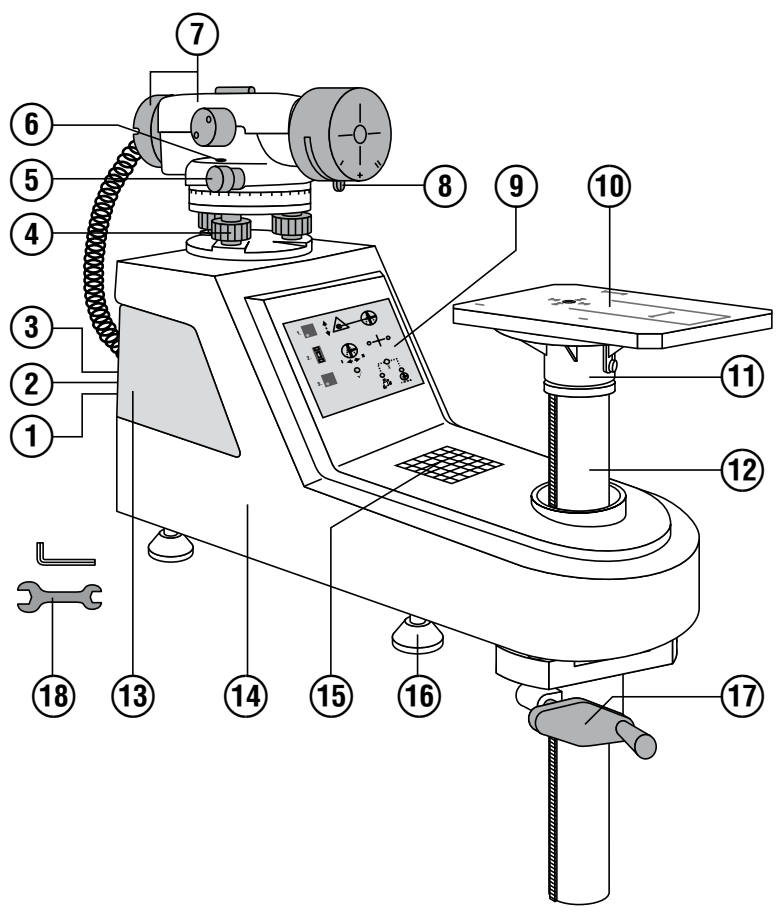

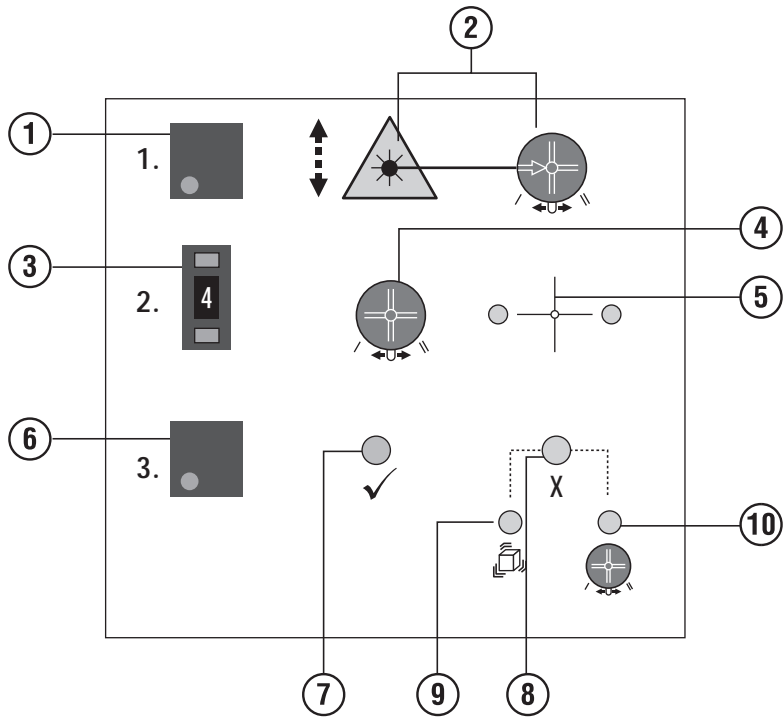

3



4

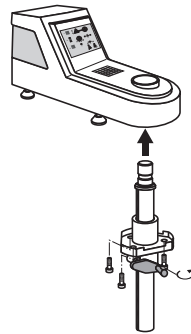

5

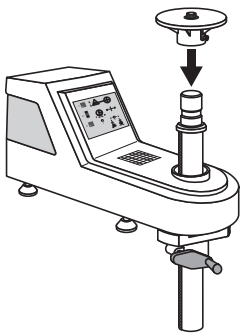

6

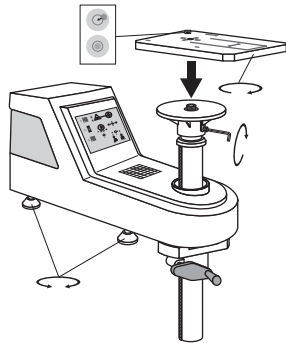

7

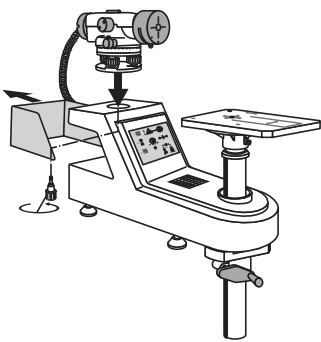

8

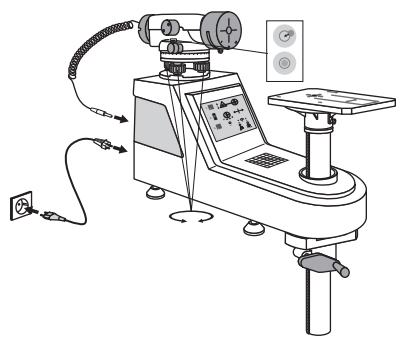

9

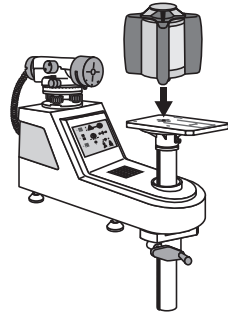
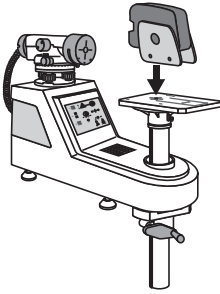

10

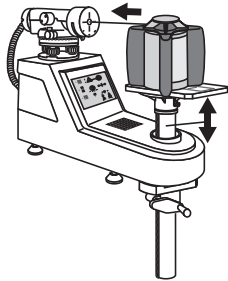
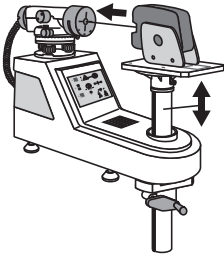

11

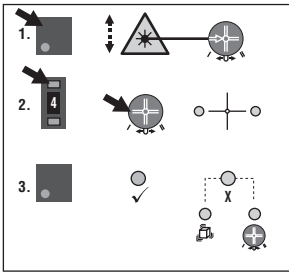

12

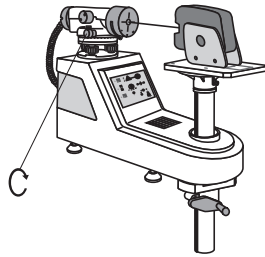

13

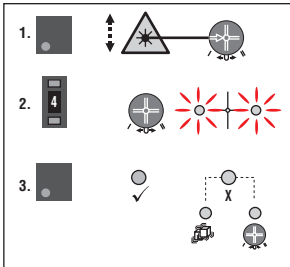

14

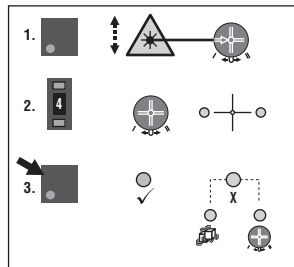

15

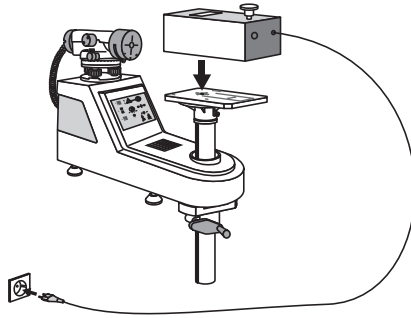

16

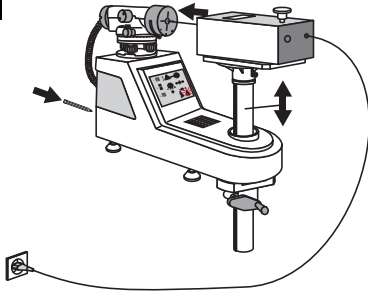

17

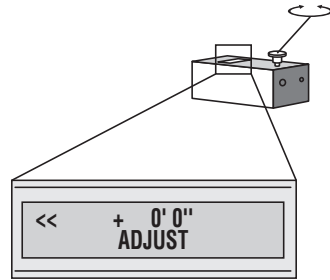

18

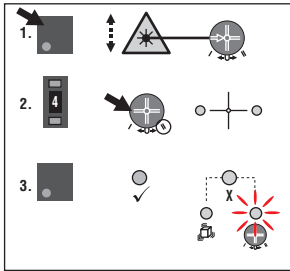

19

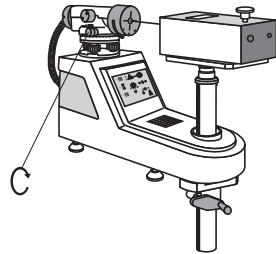

20

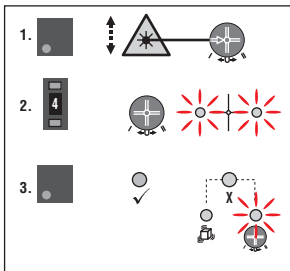

21

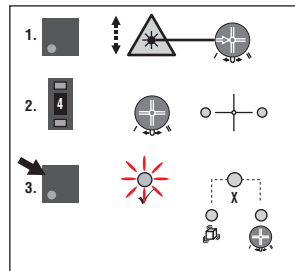

ORIGINAL OPERATING INSTRUCTIONS

PT 10 quick tester

en

It is essential that the operating instructions are read before the tool is operated for the first time.

Always keep these operating instructions together with the tool.

Ensure that the operating instructions are with the tool when it is given to other persons.

Contents	Page
1 General information	10
2 Description	11
3 Accessories	13
4 Technical data	13
5 Safety instructions	13
6 Before use	14
7 Operation	15
8 Care and maintenance	16
9 Troubleshooting	16
10 Disposal	17
11 Manufacturer's warranty - tools	17
12 FCC statement (applicable in US) / IC statement (applicable in Canada)	17
13 EC declaration of conformity (original)	18

1 These numbers refer to the illustrations. You can find the illustrations at the beginning of the operating instructions.

In these operating instructions, the designation "the tool" always refers to the PT 10 quick check device.

Component parts **1**

- 1 On-button
- 2 Mains plug
- 3 Calibration switch
- 4 Adjusting screws
- 5 Beam search fine adjustment
- 6 Bubble level
- 7 PTA 10 optical level with camera
- 8 Filter unit
- 9 Operating unit
- 10 PTA 70 tripod adapter
- 11 PTA 45 tripod head
- 12 PTA 40 tripod column
- 13 Rear cover
- 14 Concrete base
- 15 Table of Hilti tools
- 16 Screw feet
- 17 Crank
- 18 Disc or accessory

Operating unit **2**

- 1 Power indicator
- 2 Aim laser beam at center of filter
- 3 Accuracy class selector button
- 4 Filter selector
- 5 "Beam on camera" indicator
- 6 Start measuring
- 7 Laser tool within specified tolerance
- 8 Laser tool not within specified tolerance
- 9 Laser tool moved during measuring
- 10 Check filter and/or accuracy class settings

1 General information

1.1 Safety notices and their meaning

DANGER

Draws attention to imminent danger that will lead to serious bodily injury or fatality.

WARNING

Draws attention to a potentially dangerous situation that could lead to serious personal injury or fatality.

CAUTION

Draws attention to a potentially dangerous situation that could lead to slight personal injury or damage to the equipment or other property.

NOTE

Draws attention to an instruction or other useful information.

1.2 Explanation of the pictograms and other information

Warning signs



General warning

Symbols



Read the operating instructions before use.



Disposal of power tools or appliances and batteries together with household waste is not permissible.

Location of identification data on the tool

The type designation and serial number can be found on the type identification plate on the tool. Make a note of this data in your operating instructions and always refer to it when making an enquiry to your Hilti representative or service department.

Type: _____

Serial no.: _____

en

2 Description

2.1 Use of the product as directed

The PT 10 is a quick check device that allows a single person to quickly and accurately check whether the accuracy of a Hilti rotating laser, point laser or line laser is within the specified tolerance. The accuracy of the horizontal laser beam is checked in each case.

NOTE

Important! Only Hilti laser tools featuring a visible laser beam can be tested.

2.2 Features

This device allows the user to test the laser tool quickly and easily (takes approx. 50 seconds). Operation of the device is self-explanatory and the result obtained is clear and unequivocal. The PT 10 is compact and robustly built.

The accuracy of the following Hilti laser tools can be checked: line lasers, multi-line lasers, combilasers, rotating lasers and pipe lasers.

2.3 Settings in accordance with the table of Hilti tools

Hilti laser tool	Accuracy class	Filter setting
PML/ PMC/ PMM	9	I
PM 24/ PMP	9	II
PR 20/ PR 28/ PRE 3/ PRE 38/ PR 2-HS/ PR 300-HV2S	1	I
PR 25/ PR 26/ PR 35/ PR 3/ PR 30-HVS	2	I
PR 15	5	I
PR 16/ PRI 2/ PRI 36/ PR 3-HVSG	3	I
PP	1	II

The table of Hilti tools will be updated and replaced when new products are introduced.

2.4 Information displayed during operation

Small green LED	The green LED doesn't light.	The tool is switched off.
	The green LED doesn't light.	The tool is not connected to the electric supply.
	The green LED lights constantly.	Beam search for the laser beam from the tool under test is active. After searching in beam search mode unsuccessfully for 2 minutes, the PT 10 quick check device reverts automatically to standby mode.
	The green LED blinks.	Ready mode.

Small yellow LED	The yellow LED doesn't light.	The laser beam is not aimed at the opening in the filter unit and therefore not at the camera. Use the fine adjustment screws to rotate the optical level until both yellow LEDs light constantly.
	The yellow LED doesn't light.	The laser beam is not striking the camera. Check that the Hilti laser tool is switched on.
	Only one yellow LED lights.	The laser beam is striking the camera only partially. Use the fine adjustment screws to rotate the optical level until both yellow LEDs light constantly.
	Both LEDs light constantly.	The laser beam is striking the camera and the tool is ready to begin measuring.
	Both yellow LEDs blink.	Information displayed while measuring is in progress.
Large green and red LEDs	The green LED lights.	Result of test: The laser tool under test is within the specified accuracy.
	The red LED lights.	Result of test: The laser tool under test is not within the specified accuracy and must be returned to a Hilti service center for calibration.

2.5 PT 10 quick check device in cardboard box - items supplied

- 1 PT 10 quick check device
- 1 PTA 70 tripod adapter
- 1 PTA 45 tripod head
- 1 PTA 40 tripod column
- 1 Disc or accessory
- 1 Mains adaptor
- 1 Operating instructions
- 1 Manufacturer's certificate

2.6 PT 10 - associated items in separate box

- 1 PTA 10 optical level with camera

2.7 PT 10 - associated items in Hilti toolbox

- 1 PTA 20 calibration tool
- 1 Mains adaptor
- 1 Operating instructions
- 1 Manufacturer's certificate

2.8 PT 10 quick check device set in cardboard box - items supplied

- 1 PT 10 quick check device
- 1 PTA 70 tripod adapter
- 1 PTA 45 tripod head
- 1 PTA 40 tripod column
- 1 Disc or accessory
- 1 Mains adaptor

- 1 Operating instructions
- 1 Manufacturer's certificate

2.9 PT 10 set - associated items in separate box

- 1 PTA 10 optical level with camera

2.10 PT 10 set - associated items in Hilti toolbox

- 1 PTA 20 calibration tool
- 1 Mains adaptor
- 1 Operating instructions
- 1 Manufacturer's certificate

en

3 Accessories

Designation	Description
PP tripod adapter for pipe laser	PPA 73
Tripod adapter	PTA 70
Disc or accessory	
Mains adaptor	PTAW 80
Table of Hilti tools	PTAW 10

4 Technical data

Right of technical changes reserved.

Measuring time in seconds	Max. 50
Operating status indicators	LED
Power supply	DC voltage 6 V: 0.2 A
Operating temperature range	+10...+35°C
Storage temperature	+0...+50°C
Protection against dust and water spray	IP 54 (protection against dust and water spray)
Tripod thread	BSW: 5/8"
Weight	36.4 kg
Dimensions	600 mm X 190 mm X 520 mm

5 Safety instructions

WARNING! Read all safety instructions and other instructions. Failure to observe the safety precautions and instructions may result in electric shock, fire and/or serious injury. **Keep all safety precautions and instructions for future reference.**

5.1 General safety rules

- a) **Check the condition of the tool before use. If the tool is found to be damaged, have it repaired at a Hilti service center.**

- b) **The tool must be checked at a Hilti service center after it has been dropped or subjected to other mechanical stresses.**
- c) **The tool is intended exclusively for indoor use.**
- d) **Before operating the tool, check that it is complete and standing or secured in a stable position.**
- e) **The tool and its ancillary equipment may present hazards when used incorrectly by untrained personnel or when used not as directed.**

- f) Have the tool repaired only at a Hilti service center.
- g) To avoid the risk of injury, use only genuine Hilti accessories and additional equipment.
- h) Modification of the tool is not permissible.
- i) Observe the information printed in the operating instructions concerning operation, care and maintenance.
- j) Do not render safety devices ineffective and do not remove information and warning notices.
- k) Keep laser tools out of reach of children.
- l) Take the influences of the surrounding area into account. Do not use the tool where there is a risk of fire or explosion.
- m) Only laser tools featuring a visible laser beam may be checked using the PT 10 quick check device.

5.2 Proper organization of the work area

- a) Secure the working area and take care to ensure that the surface of the bench or table is steady and level when setting up the tool.
- b) Ensure that the tool is set up on a steady, level surface (not subject to vibration).
- c) Do not set up the tool at a passageway or where people frequently pass by (risk of tripping/falling and injury).
- d) Use the tool only within its specified limits.

5.3 Electromagnetic compatibility

Although the tool complies with the strict requirements of the applicable directives, Hilti cannot entirely rule out the possibility of the tool being subject to interference caused by powerful electromagnetic radiation, leading to incorrect operation. Check the accuracy of the tool by taking measurements by other means when working under such conditions or if you are unsure. Likewise, Hilti cannot rule out the possibility of interference with other devices (e.g. aircraft navigation equipment).

6 Before use



6.1 Setting up the tool 3

1. Check that the surface of the bench is flat and that it stands level.
2. Place the concrete base on a sturdy bench.
NOTE Use an open-end wrench to adjust the screw feet so that the bubble of the bubble level on the tripod adapter is inside the inner ring. Tighten all lock nuts on the screw feet securely.
3. Position the flat surface of the concrete base so that the hole for the tripod column lies beyond the edge of the bench.
NOTE Please observe the safety rules in the section "Proper organization of the work area".

6.1.1 Fitting the tripod column 4 5 6

1. Fit the tripod column through the hole in the concrete base from below and secure it with the screws.
NOTE Please note that crank must be positioned toward the front.
2. Fit the tripod head onto the tripod column.

3. Screw the PTA 70 tripod adapter onto the tripod head. Rotate the tripod adapter until the designation "PTA 70" can be read from the front and then use the hex. socket wrench supplied to tighten the screw.

6.1.2 Fitting the optical level 7

1. Unscrew the two wing screws and open the rear cover on the concrete base.
2. Place the PTA 10 optical level on the raised part of the concrete base and secure it with the adjusting screw provided.
NOTE Take care to ensure that the filter unit is directed toward the tripod head.
3. Close the rear cover on the concrete base and tighten the two wing screws.

6.1.3 Electrical connections 8

1. Connect the cable from the PTA 10 optical level to the connector on the rear of the concrete base.
2. Connect the supply cord to the rear of the concrete base.
3. Plug the supply cord into the power outlet.

6.1.4 Setting up the PT 10 quick check device in the horizontal plane 6 8

NOTE

The PT 10 must be set up in the horizontal plane before use. First use the bubble level on the tripod adapter as a reference and then the bubble level incorporated in the optical level. The bubbles of both levels must be centered (in the inner circle) before the tool can be used for measuring. Calibrate the PT 10 quick check device before use.

7 Operation



7.1 Mounting the laser tool on the tripod adapter

7.1.1 Mounting point lasers, rotating lasers or multidirectional lasers on the tripod adapter **9 10**

1. Screw the PTA 70 tripod adapter onto the tripod head.
2. Place the Hilti laser tool under test on the adapter plate and switch it on.
3. Use the crank to adjust the height of the Hilti laser tool so that the laser beam is aimed at the center of the crosshairs in the middle of the filter disc.

7.1.2 Mounting the laser tool on the adapter plate for the PP 10 and PP 11 pipe lasers

1. Screw the PPA 73 tripod adapter onto the tripod head.
2. Place the pipe laser on the tripod adapter and switch it on.
3. Use the crank to adjust the height of the Hilti laser tool so that the laser beam is aimed at the center of the crosshairs in the middle of filter disc.

7.1.3 Switching on **11**

Switch on the PT 10 quick check device.

7.2 Setting the accuracy class **11**

1. Select the applicable accuracy class 1-9 according to the table of Hilti tools.
2. Press the +/- buttons until the corresponding accuracy class appears.

7.3 Filter setting **11**

1. Select filter setting I or II according to the table of Hilti tools.
2. Move the switch on the filter disc to the corresponding position.

7.4 Adjusting the camera **12 13**

The position of the laser beam on the camera lens is indicated by the yellow LEDs.

If neither of the yellow LEDs light up or only one LED lights, turn the fine adjustment screw on the optical level until the laser beam is found.

Both yellow LEDs light up as soon as the laser beam strikes the camera. At the same time, the “Start measuring” button becomes active and the device is ready to begin the test.

7.5 Measuring **14**

NOTE

Do not touch or move the PT 10 quick check device while measuring is in progress. An error message will be displayed in the event of vibration.

The PT 10 quick check device is ready to begin measuring as soon as both yellow LEDs light and the “Start measuring” button is shown to be active.

Press the “Start measuring” button. The measuring operation is indicated by the yellow LEDs blinking and continues, on average, for approx. 50 seconds.

7.6 Indication of result

NOTE

All 4 directional axes (X, Y) of rotating lasers must always be tested.

After measuring for approx. 50 seconds, either the green or the red LED lights to indicate whether the laser tool under test is within the specified accuracy. If the green LED lights, the laser tool is within the specified accuracy. If the red LED lights, the laser tool is not within the specified accuracy and should be returned to a Hilti service center for calibration.

7.7 Repeating the test procedure

NOTE

The test procedure can be repeated with each Hilti laser tool as often as desired.

7.8 Calibration

NOTE

Monitoring of measuring equipment for users certified in accordance with ISO 9000X: The required procedure for monitoring the PT 10 quick check device within the scope of ISO 900X can be carried out by the owner. The PTA 20, a tool specially designed for the purpose of calibrating the PT 10 quick check device, is available from Hilti. Please contact Hilti Customer Service for information about the availability of this item.

7.8.1 Calibrating the PT10 quick check device **15 16 17 18 19 20 21**

NOTE

Calibration should be carried out at regular intervals. The PTA 20 calibration tool, to be used for calibrating the PT 10 quick check device, is available from Hilti. The calibration tool should be sent to a Hilti service center in advance for checking and calibration.

en

1. Mount the calibration tool on the tripod adapter of the PT 10 (15).
2. Plug the supply cord of the calibration tool into the power outlet.
3. A message appears in the display and the present accuracy deviation is shown. The calibration sequence number is also shown. The calibration sequence number increases by one after each successful calibration of a PT 10 quick check device.
4. Check the bubble level of the optical level again and correct the level if necessary by turning the optical level adjusting screws.
5. Switch on the PT 10 quick check device.
6. With the aid of a pencil or ballpoint pen, press the calibration button on the back panel of the PT 10 (16).
The small red LED on the right lights indicating calibration mode (18).
7. Select filter setting II. The accuracy class does not have to be selected.
8. Turn the crank to adjust the height of the PTA 20 calibration tool (16) so that the laser beam emitted is aimed at the center of the cross hairs on the PT 10 quick check device.
The position of the laser beam on the camera lens is indicated by the LEDs.
9. Turn the fine adjustment screw (17) on the PTA 20 until the display shows "zero".
NOTE The direction in which the fine adjustment screw should be turned is indicated by the two arrows in the display. The arrows at the beginning of the line indicate the direction in which the fine adjustment screw should be turned and the subsequent digits indicate the present deviation / inclination in arc seconds and arc minutes.
10. Both yellow LEDs light up as soon as the laser beam strikes the camera. At the same time, the "Start measuring" button becomes active and the device is ready to begin the test.
11. If neither of the yellow LEDs (19, 20) light up or only one LED lights, turn the fine adjustment screw on the optical level until the laser beam is found.
12. Press the "Start measuring" button (21). The measuring operation is indicated by the yellow LEDs blinking and continues for a maximum of 50 seconds.
NOTE Do not touch or move the PTA 20 calibration tool or the PT 10 quick check device while measuring is in progress. An error message will be displayed in the event of vibration.
The green LED lights after successful calibration and the PT 10 returns to normal operating mode. The small red LED on the right goes out.

8 Care and maintenance

8.1 Cleaning and drying

1. Blow dust off the lenses.
2. Do not touch the glass or the filter with the fingers.
3. Use only a clean, soft cloth for cleaning. If necessary, moisten the cloth slightly with pure alcohol or a little water.
NOTE Do not use any other liquids as these may damage the plastic components.
4. The temperature limits for storage of your equipment must be observed, especially in winter / summer.

8.2 Storage

Remove the appliance from its case if it has become wet. The tool, its carrying case and accessories should be cleaned and dried (at maximum 40°C / 104°F). Repack the equipment only once it is completely dry. After a long period of storage, check the calibration of the tool before use.

8.3 Transport

Use the Hilti shipping carton, the Hilti shipping case or packaging of equivalent quality for transporting or shipping your equipment.

9 Troubleshooting

Fault	Possible cause	Remedy
The PT 10 can't be switched on.	The supply cords are not (or not fully) connected.	Check the supply cord and ensure that all cords are connected correctly.
The PT 10 can't find the laser beam.	The laser beam is not aimed at the crosshairs.	Aim the laser beam at the crosshairs.
	The laser tool is not switched on.	Switch the laser tool on.
	Not a Hilti laser tool.	Only genuine Hilti laser tools can be tested.
Large red and green LEDs light constantly.	Measuring could not be completed correctly.	Repeat the measuring operation.
Small red LED (right) lights constantly.	The wrong filter is selected.	Check and correct the filter setting.

Fault	Possible cause	Remedy
Large red and small red LED (left) light constantly.	The PT 10 quick check device and/or the laser tool under test was shaken during measuring.	Repeat the measuring operation.
Large red and green LED light constantly despite several measuring attempts.	Camera error.	Remove the PTA 10 optical level and return it to a Hilti service center for repair.

10 Disposal

WARNING

Improper disposal of the equipment may have serious consequences:

The burning of plastic components generates toxic fumes which may present a health hazard.

Batteries may explode if damaged or exposed to very high temperatures, causing poisoning, burns, acid burns or environmental pollution.

Careless disposal may permit unauthorized and improper use of the equipment. This may result in serious personal injury, injury to third parties and pollution of the environment.



Most of the materials from which Hilti tools and appliances are manufactured can be recycled. The materials must be correctly separated before they can be recycled. In many countries, Hilti has already made arrangements for taking back old tools and appliances for recycling. Ask Hilti customer service or your Hilti representative for further information.



For EC countries only

Do not dispose of electrical appliances together with household waste.

In observance of the European Directive on waste electrical and electronic equipment and its implementation in accordance with national law, electrical appliances and batteries that have reached the end of their life must be collected separately and returned to an environmentally compatible recycling facility.

11 Manufacturer's warranty - tools

Please contact your local Hilti representative if you have questions about the warranty conditions.

12 FCC statement (applicable in US) / IC statement (applicable in Canada)

This device complies with part 15 of the FCC rules and with CAN ICES-3 (A) / NMB-3 (A). Operation is subject to the following two conditions:

(1) This device may not cause harmful interference.

(2) This device must accept any interference received, including interference that may cause undesired operation.

NOTE

Changes or modifications not expressly approved by Hilti may restrict the user's authorization to operate the equipment.

13 EC declaration of conformity (original)

Designation:	Quick tester
Type:	PT 10
Year of design:	2006

We declare, on our sole responsibility, that this product complies with the following directives and standards: 2011/65/EU, until 19th April 2016: 2004/108/EC, as of 20th April 2016: 2014/30/EU, until 19th April 2016: 2006/95/EC, as of 20th April 2016: 2014/35/EU, EN ISO 12100.

Hilti Corporation, Feldkircherstrasse 100,
FL-9494 Schaan



Paolo Luccini
Head of BA Quality and Process Management
Business Area Electric Tools & Accessories
03/2015



Edward Przybyłowicz
Head of BU Measuring Systems

BU Measuring Systems

03/2015

Technical documentation filed at:

Hilti Entwicklungsgesellschaft mbH
Zulassung Elektrowerkzeuge
Hiltistrasse 6
86916 Kaufering
Deutschland



Hilti Corporation

LI-9494 Schaan

Tel.: +423/234 21 11

Fax: +423/234 29 65

www.hilti.com

Hilti = registered trademark of Hilti Corp., Schaan
Pos. 1 | 20150417

