

HILTI

DX 351 BT/BTG

Operating instructions

en

Mode d'emploi

fr

Manual de instrucciones

es



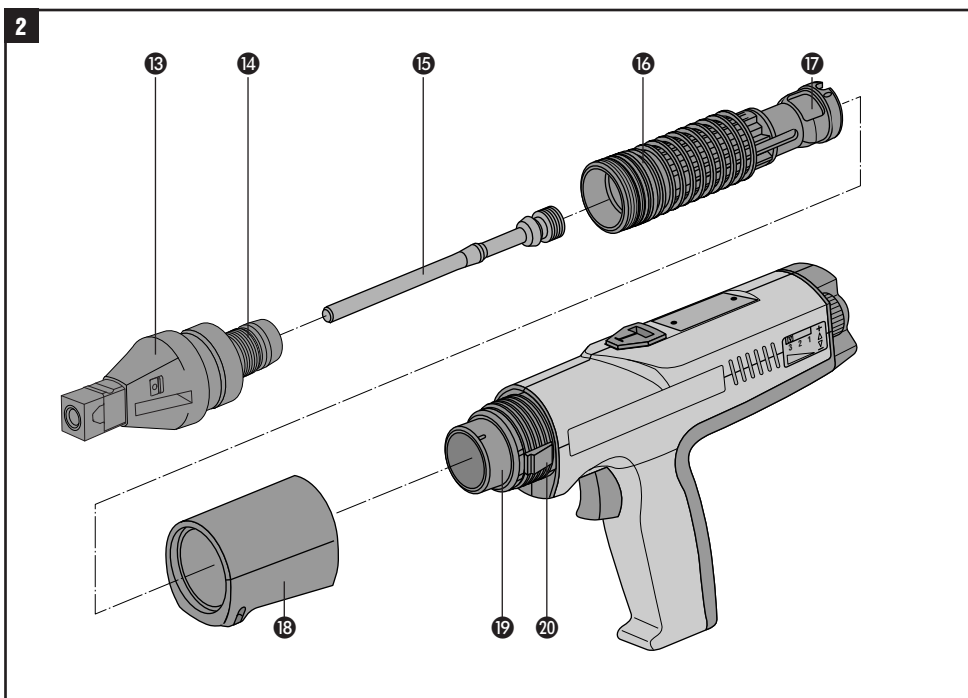
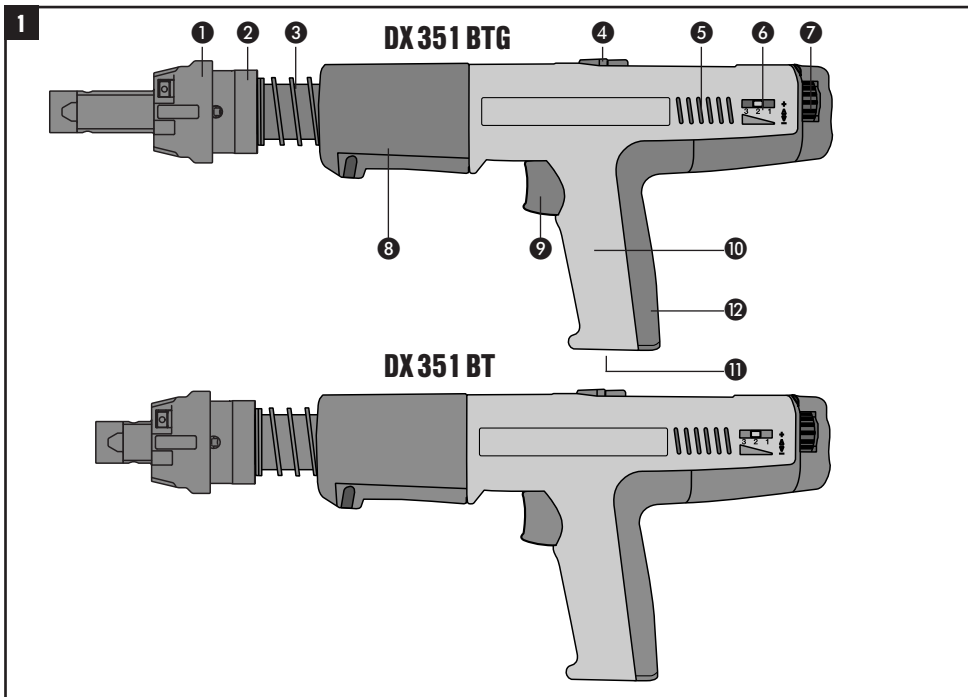

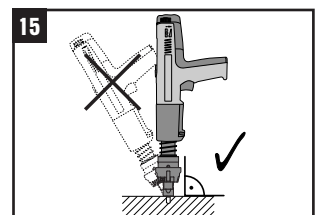
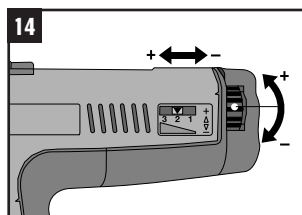
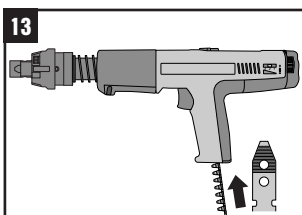
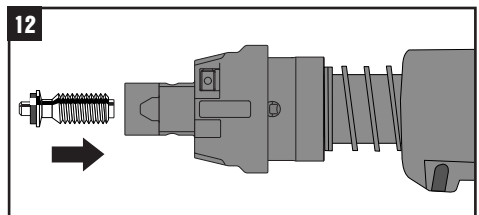
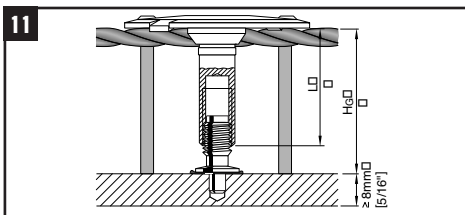
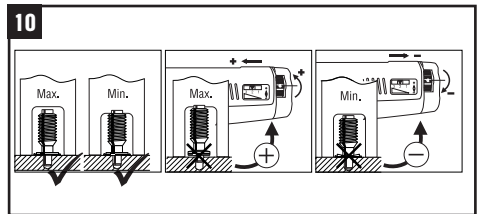
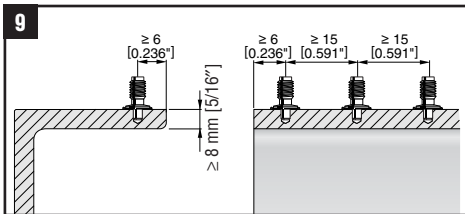
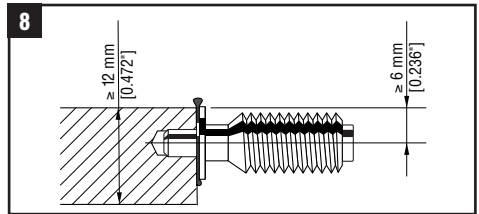
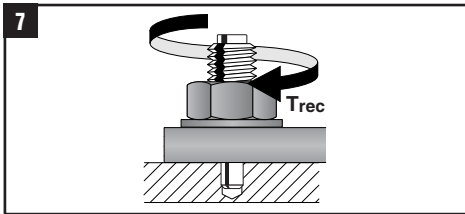
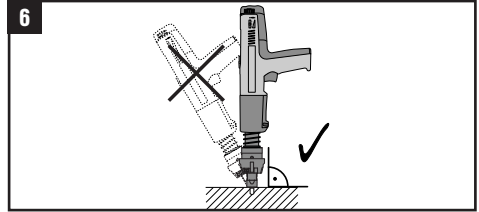
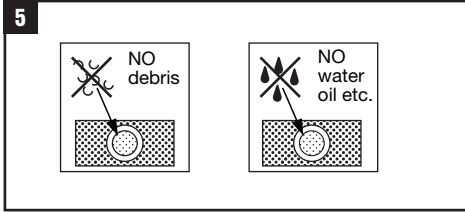
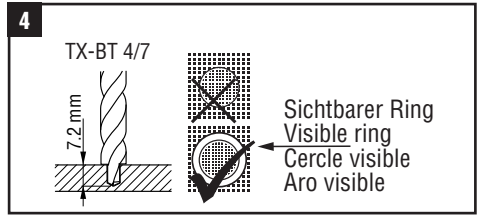
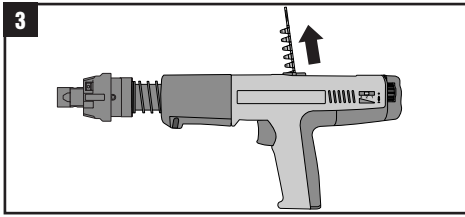

16

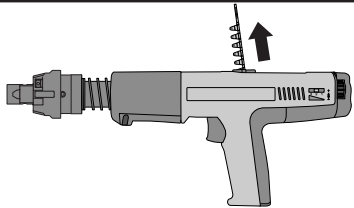

17

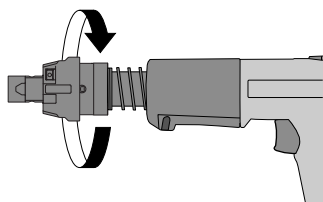

18

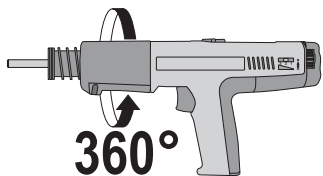

19

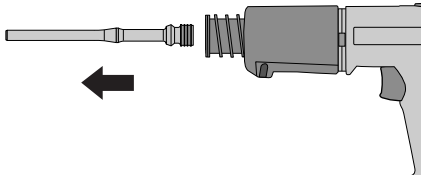

20

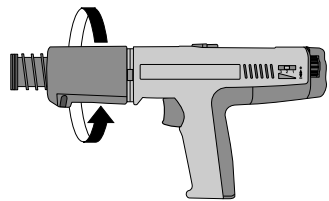

21

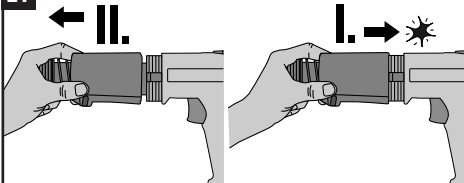

22

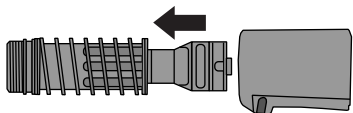

23

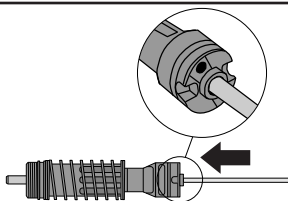

24

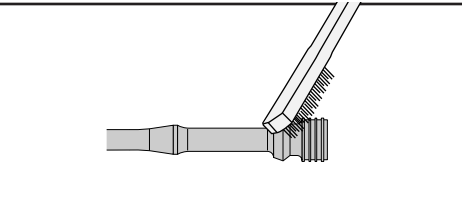
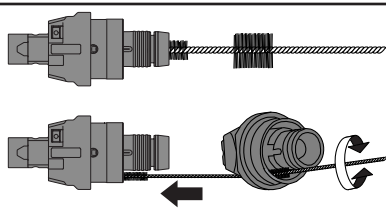

25

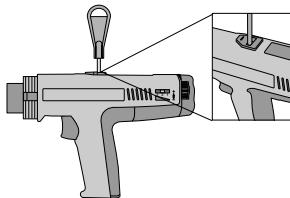

26

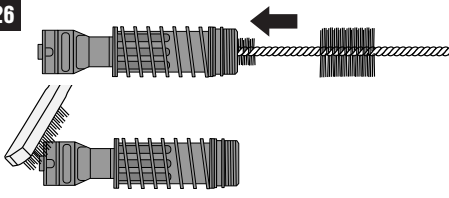

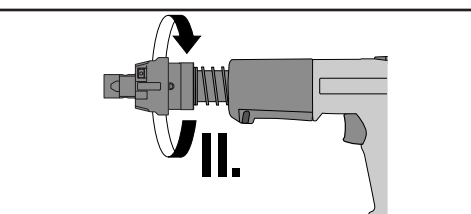
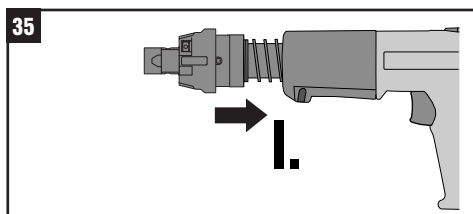
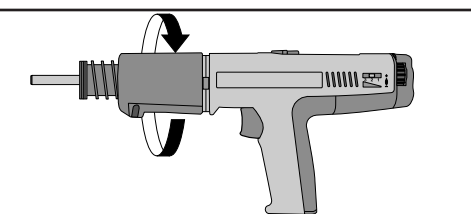
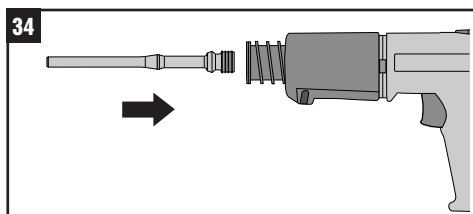
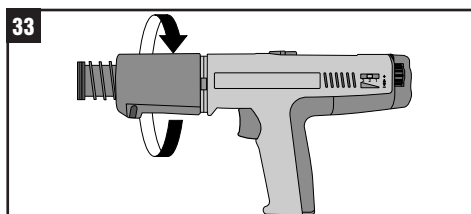
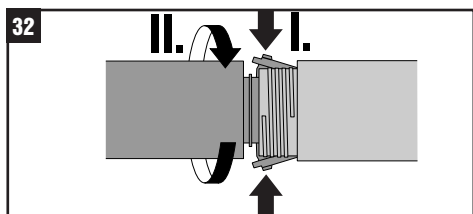
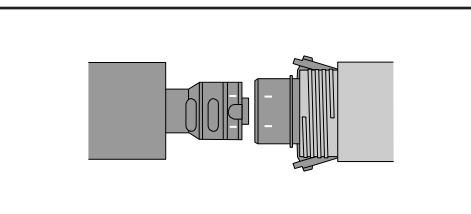
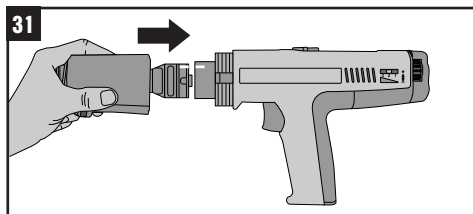
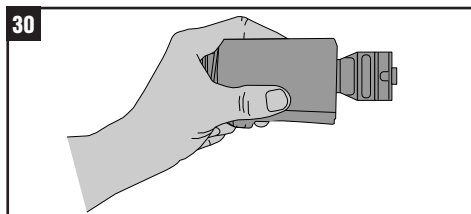
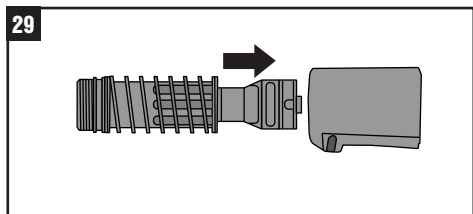
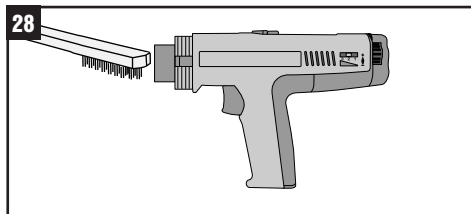
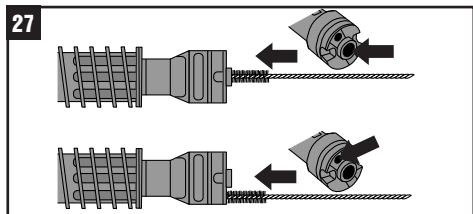

ORIGINAL OPERATING INSTRUCTIONS

DX 351 BT/BTG powder-actuated tool

It is essential that the operating instructions are read before the tool is operated for the first time.

Always keep these operating instructions together with the tool.

Ensure that the operating instructions are with the tool when it is given to other persons.

Description of main parts 1

- 1 Fastener guide
- 2 Threaded sleeve
- 3 Piston return spring
- 4 Cartridge strip ejector
- 5 Ventilation slots
- 6 Power regulation indicator
- 7 Power regulation wheel
- 8 Housing, black
- 9 Trigger
- 10 Grip
- 11 Cartridge guideway
- 12 Grip pad

Tool components 2

- 13 Fastener guide*
- 14 Piston brake
- 15 Piston*
- 16 Piston return spring
- 17 Piston guide
- 18 Casing, black
- 19 Piston stop, right
- 20 Piston stop, left

* These parts may be replaced by the user.

Contents	Page
1. Safety precautions	1
2. General information	3
3. Technical description	3
4. Insert tools and accessories	4
5. Technical data	6
6. Before use	6
7. Operation	6
8. Care and maintenance	8
9. Troubleshooting	10
10. Disposal	13
11. Manufacturer's warranty – DX tools	13
12. EC declaration of conformity (original)	13
13. CIP approval mark	14
14. Health and safety of the user	14

1. Safety precautions

1.1 Basic safety instructions

In addition to the safety precautions listed in the individual sections of these operating instructions, the following points must be strictly observed at all times.

1.2 Only use Hilti cartridges or cartridges of equivalent quality

The use of cartridges of inferior quality in Hilti tools may lead to build-up of unburned powder, which may explode and cause severe injuries to operators and bystanders. At a minimum, cartridges must either:

- a) Be confirmed by their supplier to have been successfully tested in accordance with EU standard EN 16264

NOTE:

- All Hilti cartridges for powder-actuated tools have been tested successfully in accordance with EN 16264.
- The tests defined in the EN 16264 standard are system tests carried out by the certification authority using specific combinations of cartridges and tools. The tool designation, the name of the certification authority and the system test number are printed on the cartridge packaging.

or

- b) Carry the CE conformity mark (mandatory in the EU as of July 2013).

See packaging sample at:
www.hilti.com/dx-cartridges

1.3 Use as intended

The DX 351 BT and DX 351 BTG are designed for professional use in fastening applications in construction where X-BT threaded studs are driven into steel.

1.4 Improper use



- Operate the tool only in well-ventilated working areas.
- Manipulation or modification of the tool is not permissible.
- Do not operate the tool in an explosive or flammable atmosphere, unless the tool is specially approved for such use.
- Use only original Hilti fasteners, cartridges, accessories and spare parts or those of equivalent quality.
- Observe the information printed in the operating instructions concerning operation, care and maintenance.

en

- Never point the tool at yourself or any bystander.
- Never press the muzzle of the tool against your hand or other part of your body.
- Do not drive nails into excessively hard or brittle materials such as glass, marble, plastic, bronze, brass, copper, natural rock, insulation material, hollow brick, glazed tile, thin-gauge sheet metal (< 4 mm), grey cast iron, spheroidal cast iron and gas concrete.

1.5 Technology

- This tool is designed with the latest available technology.
- The tool and its ancillary equipment may present hazards when used incorrectly by untrained personnel or not as directed.

1.6 Making the workplace safe



- Ensure that the workplace is well lit.
- Objects which could cause injury should be removed from the working area.
- Operate the tool only in well-ventilated working areas.
- The tool is for hand-held use only.
- Avoid unfavorable body positions. Work from a secure stance and stay in balance at all times
- Keep other persons, children in particular, outside the working area.
- Before using the tool, make sure that no one is standing behind or below the point where fasteners are to be driven.
- Keep the grip dry, clean and free from oil and grease.

1.7 General safety precautions



- Operate the tool only as directed and only when it is in faultless condition.
- If a cartridge misfires or fails to ignite, proceed as follows:
 1. Keep the tool pressed against the working surface for 30 seconds.
 2. If the cartridge still fails to fire, withdraw the tool from the working surface, taking care that it is not pointed towards your body or bystanders.
 3. Manually advance the cartridge strip one cartridge. Use up the remaining cartridges on the strip. Remove the used cartridge strip and dispose of it in such a way that it can be neither reused nor misused.
- Never attempt to pry a cartridge from the magazine strip or the tool.
- Keep the arms flexed when the tool is fired (do not straighten the arms).
- Never leave the loaded tool unattended.
- Always unload the tool before beginning cleaning, servicing or changing parts and before storage.

- Unused cartridges and tools not presently in use must be stored in a place where they are not exposed to humidity or excessive heat. The tool should be transported and stored in a toolbox that can be locked or secured to prevent use by unauthorized persons.

1.8 Temperature



- Do not disassemble the tool while it is hot.
- Never exceed the recommended maximum fastener driving rate (number of fastenings per hour). The tool may otherwise overheat.
- Should the plastic cartridge strip begin to melt, stop using the tool immediately and allow it to cool down.

1.9 Requirements to be met by users

- The tool is intended for professional use.
- The tool may be operated, serviced and repaired only by authorised, trained personnel. This personnel must be informed of any special hazards that may be encountered.
- Proceed carefully and do not use the tool if your full attention is not on the job.
- Stop working with the tool if you feel any pain or discomfort.

1.10 Personal protective equipment



- The operator and other persons in the immediate vicinity must always wear approved eye protection, a hard hat and suitable ear protection.

2. General information

2.1 Signal words

-WARNING-

The word WARNING is used to draw attention to a potentially dangerous situation which could lead to severe personal injury or death.

-CAUTION-

The word CAUTION is used to draw attention to a potentially dangerous situation which could lead to minor personal injury or damage to the equipment or other property.

-NOTE-

Used to draw attention to an instruction or other useful information.

2.2 Pictograms

Warning signs



General warning



Warning: hot surface



Read the operation instructions before use



Return waste material for recycling

Obligation signs



Wear eye protection



Wear a safety helmet



Wear ear protection

I The numbers refer to the illustrations. The illustrations can be found on the fold-out cover pages. Keep these pages open while you read the operating instructions.

In these operating instructions, the designation “the tool” always refers to the DX 351 BT/BTG powder-actuated tool.

Location of identification data on the tool

The type designation and the serial number are printed on the type plate on the tool. Make a note of this information in your operating instructions and always refer to it when making an enquiry to your Hilti representative or service department.

Type: DX 351 BT/BTG

Serial no.: _____

3. Technical description

The Hilti DX 351 BT and DX 351 BTG are powder-actuated fastening tools for driving X-BT threaded studs into steel.

The tool works on the well-proven piston principle and is therefore not related to high-velocity tools. The piston principle provides an optimum of working and fastening safety. The tool works with cartridges of 6.8/11 caliber.

Piston return and cartridge transport is fully automatic. This permits fastenings to be made very quickly and economically with nails and threaded studs.

As with all powder-actuated tools, the tool, magazine, fastener program and cartridge program form a “technical unit”. This means that optimal fastening with this system can only be achieved if the fasteners and cartridges are specially manufactured for it, or products of equivalent quality, are used. The fastening and application recommendations given by Hilti are only applicable if these conditions are observed.

The tool features 5-way safety – for the safety of the operator and bystanders.

The piston principle

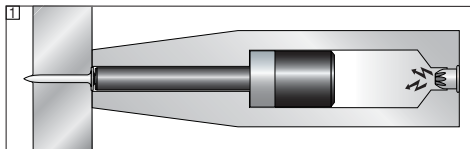

The energy from the propellant charge is transferred to a piston, the accelerated mass of which drives the fastener into the base material. As approximately 95 % of the kinetic energy is absorbed by the piston, the fastener is driven into the base material at much reduced velocity (less than 100 m/sec.) in a controlled manner. The driving process ends when the piston reaches the end of its travel. This makes dangerous through-shots virtually impossible when the tool is used correctly.

The drop-firing safety device [2] is the result of coupling the firing mechanism with the cocking movement. This is designed to help prevent the Hilti DX tool from firing when it is dropped onto a hard surface, no matter at which angle the impact occurs.

The trigger safety device [3] ensures that the cartridge cannot be fired simply by pulling the trigger only. The tool can be fired only when fully depressed.

The contact pressure safety device [4] requires the tool to be fully depressed with a significant force. The tool can be fired only when pressed fully in this way.

In addition, all Hilti DX tools are equipped with an unintentional firing safety device [5]. This prevents the tool from firing if the trigger is pulled and the tool then pressed against the work surface. The tool can be fired only when it is first pressed ① correctly and ② the trigger then pulled.

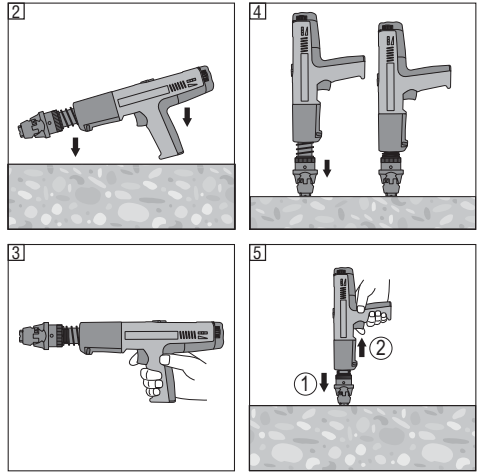

4. Insert tools and accessories

Cartridges				
Ordering designation	Item no.	Quantity	Color	Power
6.8/11 M brown, "High-precision"	377204/3	100	Brown	Extra light

These cartridges have been designed specially for the X-BT system. Their special power level ensures that driving power remains within a very narrow scatter band.

Fasteners		
Stainless steel threaded studs		
Ordering designation	Item no.	Quantity
X-BT W10-24-6 SN12-R	377076/5	100
X-BT M10-24-6 SN12-R	377078/1	100
X-BT M8-15-6 SN12-R	377074/0	100
X-BT W10-26-6-R	377075/7	100
X-BT M10-24-6-R	377077/3	100
X-BT M8-15-6-R	377073/2	100
Grating flanges		
Ordering designation	Item no.	Quantity
X-FCM-R 25/30	247181/1	100
X-FCM-R 1 1/4-1/2	247173/8	100
X-FCM-R 35/40	247171/2	100
X-FCM-R 45/50	247172/0	100

Fastener guide		
Ordering designation	Item no.	Quantity
X-351-BT FG W1024	378673/8	1
X-351-BT FG M1024	378674/6	1
X-351-BT FG G	378675/3	1

Piston		
Ordering designation	Item no.	Quantity
X-351-BT P 1024	378676/1	1
X-351-BT P G	378677/9	1

Prevention of misuse:

- When the piston tip is worn or damaged, never try to grind the tip in order to re-use the piston. This may cause serious damage to the tool and will adversely affect fastening quality.
- Please refer to the table below for the right fastener guide/piston/fastener combination. Use of the wrong combination may result in damage to the tool.

Zuitable fastener guide / piston / fastener / combinations

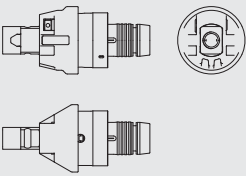
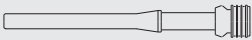
Fastener guide	Piston type	Fastener
X-351-BT FG W1024 	X-351-BT P 1024 	X-BT W10-24-6 SN12-R X-BT W10-24-6-R

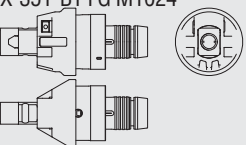
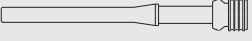
X-351-BT FG M1024 	X-351-BT P 1024 	X-BT M10-24-6 SN12-R X-BT M10-24-6-R
---	--	---

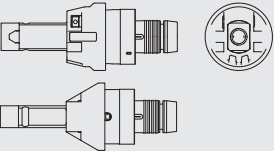
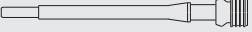
X-351-BT FG G 	X-351-BT P G 	X-BT M8-15-6 SN12-R X-BT M8-15-6-R
---	---	---------------------------------------

Accessories

Ordering designation	Item no.	Application	Qty.
X-351-BT CP coating protector	331343/9	Attachment for the fastener guide designed to prevent damage to painted surfaces.	10
X-BT PRG 8/15 power regulation guide	377088/0	For checking that fasteners (studs) are driven to the correct depth for X-BT M8 studs.	1
X-BT PRG 10/24 power regulation guide	377089/8	For checking that fasteners (studs) are driven to the correct depth for X-BT M10, X-BT W10 threaded studs.	1
TX-BT 4/7-80 stepped drill bit	377079/9	For drilling holes for the X-BT M10, X-BT W10 or X-BT M8 threaded studs. Ideal for use in narrow openings where access is restricted.	10
TX-BT 4/7-110 stepped drill bit	377080/7	For drilling holes for the X-BT M10, X-BT W10 or X-BT M8 threaded studs. Ideal for grating fastenings.	10
TX-BT 4/7-150 stepped drill bit	377081/5	For drilling holes for the X-BT M10, X-BT W10 or X-BT M8 threaded studs. Ideal for grating fastenings where the parts to be fastened are of greater height.	10
XBT4000-A drill		For drilling holes with the TX-BT4/7-... stepped drill bits	
X-BT CD 18/24 centering device	378885/8	Positioning aid for drilling holes, particularly where access is restricted.	1

Cleaning set

Hilti spray, flat brush, round brush 19/31 mm, round brush 4.5 mm, round brush 9 mm, cleaning cloth, scraper

5. Technical data

Tool	DX 351 BT	DX 351 BTG
Weight	2.28 kg (5 lbs)	2.36 kg (5.2 lbs)
Length of tool	403 mm (15.9")	431 mm (16.9")
Cartridges	6.8/11 M (27 cal. short) brown	6.8/11 M (27 cal. short) brown
Recommended max. fastener driving frequency:	700/h	700/h
Cocking movement	59 mm (2.3")	59 mm (2.3")
Cocking pressure	100 N	100 N

Right of technical modification reserved

6. Before use





6.1 Tool inspection

- Ensure that there is no cartridge strip in the tool. If there is a cartridge strip in the tool, remove it by hand from the tool. **3**

- Check all external parts of the tool for damage at regular intervals and check that all controls operate properly. Do not operate the tool when parts are damaged or when the controls do not operate properly. If necessary, have the tool repaired at a Hilti service centre.
- Check the piston for wear (see "8.4 Care and maintenance").

7. Operation



-WARNING-	
	<ul style="list-style-type: none">● The base material may splinter when a fastener is driven or fragments of the cartridge strip may fly off.
	<ul style="list-style-type: none">● Flying fragments may injure parts of the body or the eyes.● Wear safety glasses and a hard hat (users and bystanders).

-CAUTION-	
	<ul style="list-style-type: none">● The nail or stud is driven by a cartridge being fired.● Excessive noise may damage the hearing.● Wear ear protection (users and bystanders).

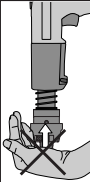
-WARNING-	
	<ul style="list-style-type: none">● Under certain circumstances, the tool can be made ready to fire by pressing it against a part of the body (e. g. a hand).● When in the "ready to fire" state, a fastener or piston could be driven into a part of the body.● Never press the nosepiece of the tool against parts of the body.

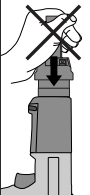
-WARNING-	
	<ul style="list-style-type: none">● Under certain circumstances, the tool can be made ready to fire by pulling back the fastener guide by hand.● When in the "ready to fire" state, a fastener or piston could be driven into a part of the body.● Never pull back the fastener guide by hand.

7.1 Fastening guidelines

-NOTE-

These application recommendations must always be observed. For more specific information, refer to the Hilti Fastening Technology Manual, which is available from your local Hilti organisation.

7.1.1 Driving threaded studs

1. Mark the point where the stud is to be driven.
2. Drill a hole. Continue drilling until the drill bit cuts a bright ring around the hole. **4**
3. Keep the hole clean (clean away any debris, dirt, water or other liquids). **5**
4. Position the threaded stud in the drilled hole and then press the tool against the working surface at right angles.
5. Pull the trigger. **6**

-NOTE-

Never regrind a stepped drill bit. System functionality can otherwise no longer be achieved.

7.2 Technical guidelines

7.2.1 Recommended torque **7**

Trec ≤ 8 Nm (5.9 ft-lb)

Hilti screwdriver	Torque setting
SF 121-A	11
SF 150-A	9
SF 180-A	8

7.2.2 Flange thickness **8**

Minimum flange thickness where the stud is driven into the edge of the flange: ≥ 12 mm (0.48 in).

7.2.3 Stud spacing **9**

Between threaded studs ≥ 15 mm (0.59 in)
Between the threaded stud and the edge of the base material. ≥ 6 mm (0.24 in)

7.3 Power settings **10**

Set the driving power on the tool to a value that drives the threaded stud to the correct depth and ensures that a good seal is achieved by the sealing washer. Start with the lowest driving power setting and increase as necessary.

7.4 Fastening gratings **11**

X-FCM-R grating flanges

Designation	Length in mm (in)	Fastenable thickness in mm (in)
X-FCM-R 25/30	23 mm (0.91")	25–32 mm (0.98–1.26")
X-FCM-R 1¼-1½	30 mm (1.18")	32–39 mm (1.26–1.54")
X-FCM-R 35/40	33 mm (1.30")	35–42 mm (1.38–1.65")
X-FCM-R 45/50	43 mm (1.69")	45–52 mm (1.77–2.05")

7.5 Loading the powder-actuated tool

1. Push the threaded stud into the tool threaded end first, as far as it will go, until it is held in place in the tool. **12**
2. Push the cartridge strip, narrow end first, into the guideway in the grip of the tool from below, until the full length of the cartridge strip is within the grip. When loading a partly-used cartridge strip, pull the cartridge strip up out of the tool from above by hand until an unused cartridge is in place in the cartridge chamber. **13**

7.6 Setting the fastener driving power

1. Use the power regulation guide to determine the correct driving power setting (the power regulation guide is enclosed in the package with the threaded studs). Perform a test fastening to verify the guideline power setting is correct.
2. If the threaded stud is not driven in to the correct position, adjust the driving power to an appropriate setting by turning the power regulation wheel. **14**

7.7 Driving a threaded stud

1. Position the threaded stud in the predrilled hole and then press the tool against the working surface at right angles. **15**
2. Pull the trigger to drive the stud.

-WARNING-

Do not attempt to redrive the same threaded stud by firing the tool a second time.

Do not drive studs into damaged or previously used holes.

7.8 Unloading the powder-actuated tool

1. Check to ensure that no cartridge strip is in the tool. If there is a cartridge strip in the tool, remove it by pulling it upwards out of the tool from above. **16**

8. Care and maintenance

When this type of tool is used under normal operating conditions, dirt and residues build up inside the tool and functionally relevant parts are also subject to wear. Regular inspections and maintenance are thus essential in order to achieve reliable operation. We recommend that the tool is cleaned and the piston and piston brake are checked at least weekly when the tool is subjected to intensive use, and at the latest after driving 2,000 fasteners.

8.1 Care of the tool

Clean the tool:

- After driving 2,000 studs
- If cartridges misfire
- If driving power is not constant
- If moving parts do not operate freely

The outer casing of the tool is manufactured from impact-resistant plastic. The grip comprises a synthetic rubber section. The ventilation slots must be unobstructed and kept clean at all times. Do not permit foreign objects to enter the interior of the tool. Use a slightly damp cloth to clean the outside of the tool at regular intervals. Do not use a spray or steam-cleaning system for cleaning.

8.2 Maintenance

Check all external parts of the tool for damage at regular intervals and check that all controls operate properly. Do not operate the tool when parts are damaged or when the controls do not operate properly. If necessary, have the tool repaired at a Hilti service centre.

-CAUTION- when cleaning:

- Never use grease for the maintenance/lubrication of parts of the tool. This may lead to malfunctions. Use only Hilti lubricant spray or a product of comparable quality.
- The residues deposited inside DX tools contain substances that may be injurious to your health:
 - Do not inhale any dust or dirt while cleaning.
 - Keep the dust or dirt away from foodstuffs.
 - Wash your hands after cleaning the tool.

	-CAUTION-
	<ul style="list-style-type: none"> ● The tool can get hot while operating. ● You could burn your hands. ● Do not disassemble the tool while it is hot. Let the tool cool down.

8.3 Disassembling the tool

1. Check to ensure that no cartridge strip is in the tool. If there is a cartridge strip in the tool, remove it by pulling it upwards out of the tool from above.
2. Unscrew and remove the fastener guide. **17**

3. Rotate the black housing counterclockwise through one complete revolution (360°). This releases the piston stop. **18**
4. Remove the piston from the tool. **19**

-NOTE-

If the piston is jammed in the piston guide, the complete piston guide must be removed from the tool.

5. Unscrew and remove the black housing completely by turning it counterclockwise. **20**
6. Press the piston guide against the tool with the palm of the hand.
7. Pull the complete unit away from the tool. **21**
8. Pull the black housing away from the piston guide. **22**
9. Pull the piston out of the piston guide.

8.4 Checking the piston for wear

The piston must be replaced if it is:

- badly worn
- broken
- bent (check by rolling it on a flat surface).

-WARNING-

Should the tip of the piston become worn or damaged, do not attempt to grind it off in order to permit further use. This may negatively affect the quality of the fastening obtained and may result in serious damage to the tool.

8.5 Cleaning the piston

1. Clean the piston with a flat brush. **23**
2. Spray the piston lightly with Hilti spray.

8.6 Cleaning the fastener guide **24**

1. Clean the fastener guide with a small round brush.
2. Spray the fastener guide lightly with Hilti spray.

8.7 Cleaning the cartridge strip guideway **25**

1. Clean the right and the left cartridge strip guideway with the scraper supplied.

8.8 Cleaning the piston guide

1. Clean the inside of the piston guide with a round brush and the outside with a flat brush. **26**
2. Clean the cartridge chamber and the power regulation bore in the end of the piston guide. **26**
3. Spray the inside and the outside of the piston guide lightly with Hilti spray.

8.9 Cleaning inside the housing

1. Clean the inside of the housing with the flat brush. **27**
2. Spray the housing lightly with Hilti spray.

8.10 Assembling the tool

1. Fit the black housing onto the piston guide. **28**
2. Pull the black housing upwards against the spring pressure and hold it securely in this position in your hand. **29**

3. Fit the complete unit into the tool so that the marks on the piston guide and on the metal housing are in alignment. **30**
4. Press in the piston stops when the piston guide has been inserted far enough for the stops to fit into the openings at the side of the piston guide. **31**
5. Release the black housing and screw it on to the tool (only 1–2 turns). **32**
6. Push in the piston as far as it will go. The piston can be inserted only before the black housing is screwed on fully (before the final turn). Then screw on the black housing as far as it will go (until it engages). **33**
7. Press the fastener guide firmly against the piston guide and then screw it on until it engages. **34**

8.11 Checking the tool following care and maintenance

After carrying out care and maintenance on the tool, check that all protective and safety devices are fitted and that they function correctly.

-CAUTION-

The use of lubricants other than Hilti spray could damage rubber parts, especially the buffer.

9. Troubleshooting

en

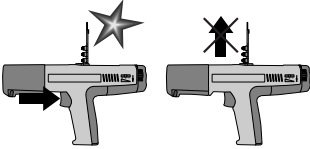
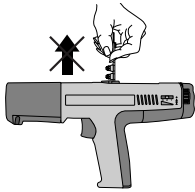
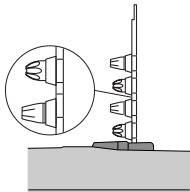
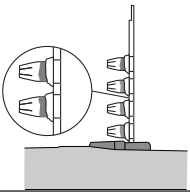
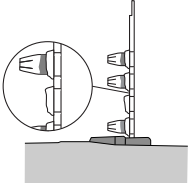
Fault	Possible cause	Remedy
<p>Cartridge not transported</p> 	<ul style="list-style-type: none"> ■ Damaged cartridge strip ■ Carbon build-up ■ Tool damaged 	<ul style="list-style-type: none"> ■ Clean the cartridge strip guide-way (see 24) <p>If the problem persists:</p> <ul style="list-style-type: none"> ■ Contact Hilti Repair Centre
<p>Cartridge strip cannot be removed</p> 	<ul style="list-style-type: none"> ■ Tool overheated because of high setting rate ■ Tool damaged <p>-WARNING- Never attempt to pry a cartridge from the magazine strip or tool.</p>	<ul style="list-style-type: none"> ■ Let the tool cool down and then carefully try to remove the cartridge strip (If the problem persists: Contact Hilti Repair Center) ■ Contact Hilti Repair Center
<p>Cartridge doesn't fire</p> 	<ul style="list-style-type: none"> ■ Bad cartridge ■ Carbon build-up <p>-WARNING- Never attempt to pry a cartridge from the magazine strip or tool.</p>	<ul style="list-style-type: none"> ■ Manually advance the cartridge strip one cartridge ■ If the problem occurs more often: Clean the tool (If the problem persists: Contact Hilti Repair Center)
<p>Cartridge strip melts</p> 	<ul style="list-style-type: none"> ■ Tool is compressed too long while fastening. ■ Fastening frequency is too high 	<ul style="list-style-type: none"> ■ Compress the tool only briefly while fastening. ■ Remove the cartridge strip ■ Disassemble the tool for fast cooling and to avoid possible damage (If the tool cannot be disassembled: Contact Hilti Repair Center)
<p>Cartridge falls out of the cartridge strip</p> 	<ul style="list-style-type: none"> ■ Fastening frequency is too high <p>-WARNING- Never attempt to pry a cartridge from the magazine strip or tool.</p>	<ul style="list-style-type: none"> ■ Immediately discontinue using the tool ■ Remove cartridge strip ■ Let the tool cool down ■ Clean the tool and remove loose cartridge. (If it is impossible to disassemble the tool: Contact Hilti Repair Center)

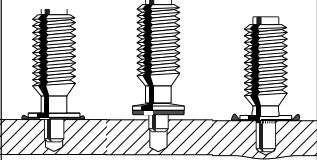
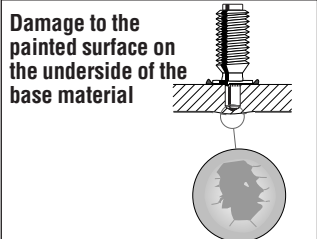
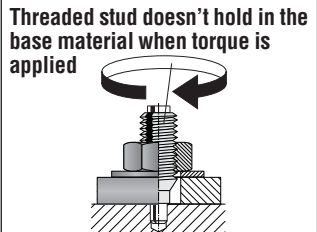
Fault	Possible cause	Remedy
<p>The operator notices:</p> <ul style="list-style-type: none"> ■ increased contact pressure ■ increased trigger force ■ power regulation stiff to adjust ■ cartridge strip is difficult to remove 	<ul style="list-style-type: none"> ■ Carbon build-up 	<ul style="list-style-type: none"> ■ Clean the tool ■ Check that the correct cartridges are used (see 1.2) and that they are in faultless condition.
<p>Threaded studs driven to different depths or sealing washer pressure/contact not constant</p> 	<ul style="list-style-type: none"> ■ Hole not deep enough ■ Piston broken or damaged ■ Fastener guide damaged ■ Damaged protective cover ■ Tool misfires ■ Wrong driving power setting ■ Carbon build-up 	<ul style="list-style-type: none"> ■ Drill to correct depth => visible ring 4. ■ Replace the piston. ■ Replace the fastener guide. ■ Replace the protective cover. ■ Change the cartridge strip (take a strip from a new, dry package if necessary). Clean the cartridge strip guideway and cartridge chamber. ■ Check driving power using the power regulation guide. ■ Clean the tool.
<p>Damage to the painted surface on the underside of the base material</p> 	<ul style="list-style-type: none"> ■ Stud driven too deeply ■ Dirt or foreign matter in the hole ■ Steel base material too thin (< 8 mm) ■ Hole not deep enough 	<ul style="list-style-type: none"> ■ Reduce driving power (power regulation). ■ Remove liquids, debris, or other foreign matter from the hole before installing the stud. ■ Drive studs only on steel base material ≥ 8 mm. ■ Drill to correct depth => visible ring 4.
<p>Threaded stud doesn't hold in the base material when torque is applied</p> 	<ul style="list-style-type: none"> ■ Dirt or foreign matter in the hole ■ Hole not deep enough ■ Hole damaged or previously used ■ Wrong drill bit used ■ Too much torque applied 	<ul style="list-style-type: none"> ■ Remove liquids, debris, or other foreign matter from the hole before installing the stud. ■ Drill to correct depth => visible ring 4. ■ Drill new hole. ■ Use appropriate drill bit ■ Use appropriate amount of torque (see 7.2.1 Recommended torque)

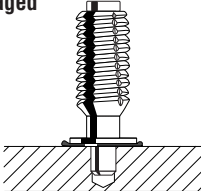
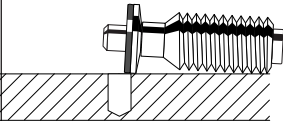
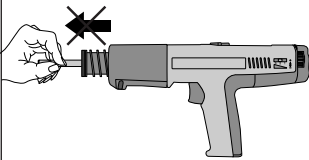
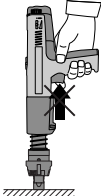
Fault	Possible cause	Remedy
<p>The thread on the stud is damaged</p> 	<ul style="list-style-type: none"> ■ Fastener guide damaged 	<ul style="list-style-type: none"> ■ Replace the fastener guide.
<p>Stud doesn't hold in the base material</p> 	<ul style="list-style-type: none"> ■ Steel base material too thin (< 8 mm) ■ Hole damaged or previously used ■ Driving power too low ■ Hole not deep enough ■ Wrong drill bit used ■ Dirt/debris in hole 	<ul style="list-style-type: none"> ■ Drive studs only on steel base material \geq 8 mm. ■ Drill new hole. ■ Increase driving power. ■ Drill to correct depth => visible ring 4. ■ Use correct drill bit ■ Remove liquids, debris or other foreign matter from the hole before installing the stud.
<p>Piston jams in the piston guide</p> 	<ul style="list-style-type: none"> ■ Damaged piston ■ Carbon build-up 	<ul style="list-style-type: none"> ■ Remove the cartridge strip ■ Piston guide ■ Check the piston and replace it if necessary ■ Clean the tool
<p>Trigger can't be pulled</p> 	<ul style="list-style-type: none"> ■ Tool not pressed fully against the work surface ■ Piston fitted incorrectly ■ Tool defective 	<ul style="list-style-type: none"> ■ Press the tool fully against the work surface. ■ Fit the piston correctly. ■ Contact your Hilti Center.

10. Disposal



Most of the materials from which Hilti power actuated tools are manufactured can be recycled. The materials must be correctly separated before they can be recycled. In many countries, Hilti has already made arrangements for taking back your old powder actuated tools

for recycling. Please ask your Hilti customer service department or Hilti sales representative for further information.

Should you wish to return the power actuated tool yourself to a disposal facility for recycling, proceed as follows: Dismantle the tools as far as possible without the need for special tools.

en

11. Manufacturer's warranty – DX Tools

Hilti warrants that the tool supplied is free of defects in material and workmanship. This warranty is valid so long as the tool is operated and handled correctly, cleaned and serviced properly and in accordance with the Hilti Operating Instructions, and the technical system is maintained. This means that only original Hilti consumables, components and spare parts, or other products of equivalent quality, may be used in the tool.

This warranty provides the free-of-charge repair or replacement of defective parts only over the entire lifespan of the tool. Parts requiring repair or replacement as a result of normal wear and tear are not covered by this warranty.

Additional claims are excluded, unless stringent national rules prohibit such exclusion. In particular,

Hilti is not obligated for direct, indirect, incidental or consequential damages, losses or expenses in connection with, or by reason of, the use of, or inability to use the tool for any purpose. Implied warranties of merchantability or fitness for a particular purpose are specifically excluded.

For repair or replacement, send tool or related parts immediately upon discovery of the defect to the address of the local Hilti marketing organization provided.

This constitutes Hilti's entire obligation with regard to warranty and supersedes all prior or contemporaneous comments and oral or written agreements concerning warranties.

12. EC declaration of conformity (original)

Designation:	Powder-actuated tool
Type:	DX 351BT/BTG
Year of design:	2003

We declare, on our sole responsibility, that this product complies with the following directives and standards: 2006/42/EC, 2011/65/EU.

**Hilti Corporation, Feldkircherstrasse 100,
FL-9494 Schaan**

Handwritten signature of Norbert Wohlwend in black ink.

Norbert Wohlwend
Head of Quality & Processes Management
BU Direct Fastening
08/2012

Handwritten signature of Tassilo Deinzer in black ink.

Tassilo Deinzer
Head BU Measuring Systems
BU Measuring Systems
08/2012

Technical documentation filed at:
Hilti Entwicklungsgesellschaft mbH
Zulassung Elektrowerkzeuge
Hiltistrasse 6
86916 Kaufering
Deutschland

13. Confirmation of CIP testing

The Hilti DX351 BT and DX351 BTG have been system and type tested. As a result, the tools bear the square-shaped PTB approval mark showing approval number **S 807**. In this way, Hilti guarantees compliance with the approved type.

Unacceptable/inadmissible defects, deficiencies, etc. that are determined during use of the tool must be reported to the manager responsible at the approval authority (PTB) and to the Office of the Permanent International Commission (C.I.P.).

14. Health and safety of the user

Noise information

The following table provides noise measurement information:

Powder-actuated tool

Type:	DX 351-BT / DX 351 BTG
Model:	Serial production
Caliber:	6.8/11 brown
Power setting:	3
Application:	Fastening of X-BT M10-24-6 onto pre-drilled steel plating 8 mm thick

Declared measured values of noise characteristics according to 2006/42/EC Machinery Directive in conjunction with E DIN EN 15895

Noise (power) level:	$L_{WA, 1s}^1$	109 dB(A)
Emission noise-pressure level in the work station:	$L_{pA, 1s}^2$	105 dB(A)
Peak sound pressure emission level:	$L_{pC, peak}^3$	136 dB(C)

Operation and set-up conditions:

Set-up and operation of the pin driver in accordance with E DIN EN 15895-1 in the semi-anechoic test room of Müller-BBM GmbH. The ambient conditions in the test room conform to DIN EN ISO 3745.

Testing procedure:

Enveloping surface method in anechoic room on reflective surface area in accordance with E DIN EN 15895, DIN EN ISO 3745 and DIN EN ISO 11201.

NOTE: The noise emissions measured and the associated measurement uncertainty represent the upper limit for the noise values to be expected during the measurements.

Variations in operating conditions may cause deviations from these emission values.

¹ ± 2 dB (A)

² ± 2 dB (A)

³ ± 2 dB (C)

Vibration

The declared total vibration value according to 2006/42/EC does not exceed 2.5 m/s².

Further information regarding the health and safety of the user can be found at the Hilti web site: www.hilti.com/hse



Hilti Corporation

LI-9494 Schaan

Tel.: +423 / 234 21 11

Fax: +423 / 234 29 65

www.hilti.com

Hilti = registered trademark of Hilti Corp., Schaan

W 2734 | 0813 | 5-Pos. 2 | 1

Printed in Liechtenstein © 2013

Right of technical and programme changes reserved S. E. & O.

377626 / A3

