

HILTI

TE 7

English



1 Information about the documentation



1.1 About this documentation

- Read this documentation before initial operation or use. This is a prerequisite for safe, trouble-free handling and use of the product.
- Observe the safety instructions and warnings in this documentation and on the product.
- Always keep the operating instructions with the product and make sure that the operating instructions are with the product when it is given to other persons.

1.2 Explanation of signs used



1.2.1 Warnings

Warnings alert persons to hazards that occur when handling or using the product. The following signal words are used in combination with a symbol:

	DANGER! Draws attention to imminent danger that will lead to serious personal injury or fatality.
	WARNING! Draws attention to a potential hazard that could lead to serious personal injury or fatality.
	CAUTION! Draws attention to a potentially dangerous situation that could lead to minor personal injury or damage to the equipment or other property.



1.2.2 Symbols in the documentation

The following symbols are used in this document:

	Read the operating instructions before use
	Instructions for use and other useful information

1.2.3 Symbols in the illustrations





The following symbols are used in illustrations:

	These numbers refer to the corresponding illustrations found at the beginning of these operating instructions.
3	The numbering reflects the sequence of operations shown in the illustrations and may deviate from the steps described in the text.
	Item reference numbers are used in the overview illustrations and refer to the numbers used in the product overview section .
	These characters are intended to specifically draw your attention to certain points when handling the product.

1.3 Product-dependent symbols

1.3.1 Symbols

The following symbols are used:

	Drilling without hammer action
	Drilling with hammering action (hammer drilling)
	Forward / reverse
n_0	Rated speed under no load
/min	Revolutions per minute
	Protection class II (double-insulated)

1.4 Product information

Hilti products are designed for professional use and may be operated, serviced and maintained only by trained, authorized personnel. This personnel must be informed of any particular hazards that may be encountered. The product and its ancillary equipment can present hazards if used incorrectly by untrained personnel or if used not in accordance with the intended use.

The type designation and serial number are stated on the rating plate.

- ▶ Write down the serial number in the table below. You will be required to state the product details when contacting Hilti Service or your local Hilti organization to inquire about the product.

Product information

Rotary hammer	TE 7
Generation	02
Serial no.	

1.5 Declaration of conformity

We declare, on our sole responsibility, that the product described here complies with the applicable directives and standards. A copy of the declaration of conformity can be found at the end of this documentation.

The technical documentation is filed and stored here:

Hilti Entwicklungsgesellschaft mbH | Tool Certification | Hiltistrasse 6 | 86916 Kaufering, Germany

2 Safety

2.1 General power tool safety warnings

WARNING

Read all safety warnings and all instructions. Failure to follow the warnings and instructions may result in electric shock, fire and/or serious injury.

Save all warnings and instructions for future reference.

The term "power tool" in the warnings refers to your mains-operated (corded) power tool or battery-operated (cordless) power tool.

Work area safety

- ▶ **Keep work area clean and well lit.** Cluttered or dark areas invite accidents.
- ▶ **Do not operate power tools in explosive atmospheres, such as in the presence of flammable liquids, gases or dust.** Power tools create sparks which may ignite the dust or fumes.
- ▶ **Keep children and bystanders away while operating a power tool.** Distractions can cause you to lose control.

Electrical safety

- ▶ **Power tool plugs must match the outlet. Never modify the plug in any way. Do not use any adapter plugs with earthed (grounded) power tools.** Unmodified plugs and matching outlets will reduce risk of electric shock.
- ▶ **Avoid body contact with earthed or grounded surfaces, such as pipes, radiators, ranges and refrigerators.** There is an increased risk of electric shock if your body is earthed or grounded.
- ▶ **Do not expose power tools to rain or wet conditions.** Water entering a power tool will increase the risk of electric shock.
- ▶ **Do not abuse the cord. Never use the cord for carrying, pulling or unplugging the power tool. Keep cord away from heat, oil, sharp edges or moving parts.** Damaged or entangled cords increase the risk of electric shock.
- ▶ **When operating a power tool outdoors, use an extension cord suitable for outdoor use.** Use of a cord suitable for outdoor use reduces the risk of electric shock.
- ▶ **If operating a power tool in a damp location is unavoidable, use a residual current device (RCD) protected supply.** Use of an RCD reduces the risk of electric shock.

Personal safety

- ▶ **Stay alert, watch what you are doing and use common sense when operating a power tool. Do not use a power tool while you are tired or under the influence of drugs, alcohol or medication.** A moment of inattention while operating power tools may result in serious personal injury.
- ▶ **Use personal protective equipment. Always wear eye protection.** Protective equipment such as dust mask, non-skid safety shoes, hard hat, or hearing protection used for appropriate conditions will reduce personal injuries.

- ▶ **Prevent unintentional starting. Ensure the switch is in the off-position before connecting to power source and/or battery pack, picking up or carrying the tool.** Carrying power tools with your finger on the switch or energising power tools that have the switch on invites accidents.
- ▶ **Remove any adjusting key or wrench before turning the power tool on.** A wrench or a key left attached to a rotating part of the power tool may result in personal injury.
- ▶ **Do not overreach. Keep proper footing and balance at all times.** This enables better control of the power tool in unexpected situations.
- ▶ **Dress properly. Do not wear loose clothing or jewellery. Keep your hair, clothing and gloves away from moving parts.** Loose clothes, jewellery or long hair can be caught in moving parts.
- ▶ **If devices are provided for the connection of dust extraction and collection facilities, ensure these are connected and properly used.** Use of dust collection can reduce dust-related hazards.

Power tool use and care

- ▶ **Do not force the power tool. Use the correct power tool for your application.** The correct power tool will do the job better and safer at the rate for which it was designed.
- ▶ **Do not use the power tool if the switch does not turn it on and off.** Any power tool that cannot be controlled with the switch is dangerous and must be repaired.
- ▶ **Disconnect the plug from the power source and/or the battery pack from the power tool before making any adjustments, changing accessories, or storing power tools.** Such preventive safety measures reduce the risk of starting the power tool accidentally.
- ▶ **Store idle power tools out of the reach of children and do not allow persons unfamiliar with the power tool or these instructions to operate the power tool.** Power tools are dangerous in the hands of untrained users.
- ▶ **Maintain power tools. Check for misalignment or binding of moving parts, breakage of parts and any other condition that may affect the power tool's operation. If damaged, have the power tool repaired before use.** Many accidents are caused by poorly maintained power tools.
- ▶ **Keep cutting tools sharp and clean.** Properly maintained cutting tools with sharp cutting edges are less likely to bind and are easier to control.
- ▶ **Use the power tool, accessories and tool bits etc. in accordance with these instructions, taking into account the working conditions and the work to be performed.** Use of the power tool for operations different from those intended could result in a hazardous situation.

Service

- ▶ **Have your power tool serviced by a qualified repair person using only identical replacement parts.** This will ensure that the safety of the power tool is maintained.

2.2 Hammer safety warnings

- ▶ **Wear ear protectors.** Exposure to noise can cause hearing loss.
- ▶ **Use auxiliary handles, if supplied with the tool.** Loss of control can cause personal injury.
- ▶ **Hold power tool by insulated gripping surfaces, when performing an operation where the cutting accessory may contact hidden wiring or its own cord.** Cutting accessory contacting a "live" wire may make exposed metal parts of the power tool "live" and could give the operator an electric shock.

2.3 Additional safety instructions

Personal safety

- ▶ **Modification of the power tool is not permitted.**
- ▶ **Keep the grips dry, clean and free from oil and grease.**
- ▶ **Check that the side handle is fitted correctly and tightened securely. Always hold the tool securely with both hands on the grips provided.**
- ▶ **Improve the blood circulation in your fingers by relaxing your hands and exercising your fingers during breaks between working.**
- ▶ **The power tool is not intended for use by debilitated persons who have received no special training.**
- ▶ **Keep the power tool out of reach of children.**
- ▶ **Avoid touching rotating parts. Switch the power tool on only after bringing it into position at the workpiece.** Touching rotating parts, especially rotating drill bits or other accessories, may lead to injury.
- ▶ **Dust from materials, such as paint containing lead, some wood species, concrete / masonry / stone containing silica, and minerals as well as metal, may be harmful. Contact with or inhalation of the dust may cause allergic reactions and/or respiratory or other diseases to the operator or bystanders. Certain kinds of dust are classified as carcinogenic such as oak and beech dust, especially in conjunction with additives for wood conditioning (chromate, wood preservative). Material containing asbestos may be handled only by specialists. Use a dust removal system whenever possible. To achieve a high level**

of dust collection, use a suitable vacuum cleaner. When indicated, wear a respirator appropriate for the type of dust generated. Ensure that the workplace is well ventilated. Follow national requirements for the materials you want to work with.

- ▶ **Before beginning the work, check the hazard classification of the dust that will be produced. Use an industrial vacuum cleaner with an officially approved protection classification in compliance with locally applicable dust protection regulations.**
- ▶ **Observe the national health and safety requirements.**

Careful handling and use of power tools

- ▶ **Secure the workpiece. Use clamps or a vice to secure the workpiece.** The workpiece is thus held more securely than by hand and both hands remain free to operate the power tool.
- ▶ **Ensure that the accessory tools used have a mounting system that is compatible with the electric tool and that they are secured in the chuck correctly.**
- ▶ **In the event of a power failure or interruption in the electric supply, switch the power tool off, unplug the supply cord and release the switch lockbutton (if applicable).** This will prevent accidental restarting when the electric power returns.

Electrical safety

- ▶ **Before beginning work, check the working area (e.g. using a metal detector) to ensure that no concealed electric cables or gas and water pipes are present.** External metal parts of the tool may become live, for example, when an electric power line is damaged accidentally. This presents a serious risk of electric shock.
- ▶ **Check the tool's supply cord at regular intervals and have it replaced by a qualified specialist if found to be damaged. If the tool's supply cord is damaged it must be replaced with a specially-prepared and approved supply cord available from Hilti Customer Service. Check extension cords at regular intervals and replace them if found to be damaged. Do not touch the supply cord or extension cord if it is damaged while working. Disconnect the supply cord plug from the power outlet.** Damaged supply cords or extension cords present a risk of electric shock.
- ▶ **Dirty or dusty power tools that have been used frequently for work on conductive materials should be checked at regular intervals at a Hilti Service Center.** Dust (especially dust from conductive materials) or dampness adhering to the surface of the power tool may, under unfavorable conditions, lead to electric shock.

Work area

- ▶ **If the work involves breaking right through, take the appropriate safety measures at the opposite side.** Parts breaking away could fall out and / or fall down and injure other persons.

Personal safety

- ▶ **Wear protective gloves.** The rotary hammer may get hot during use. There is a risk of injury (cutting or burning) if the accessory tool is touched while changing it.

3 Description

3.1 Overview of the product

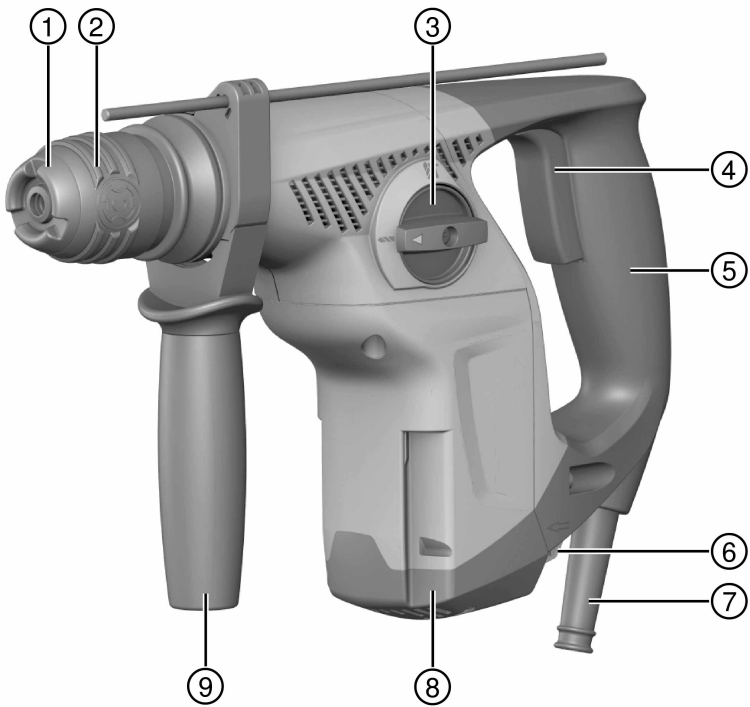

- | | |
|----------------------------|---|
| ① Dust shield | ⑥ Forward / reverse switch |
| ② Chuck | ⑦ Supply cord |
| ③ Function selector switch | ⑧ Connection for the dust collection module |
| ④ Control switch | ⑨ Side handle with depth gauge |
| ⑤ Grip | |

3.2 Intended use

The product described is an electrically powered rotary hammer. It is designed for drilling in concrete, masonry, drywall panel, wood, plastic and metal.

- ▶ The power tool may be operated only when connected to a power supply providing a voltage and frequency in compliance with the information given on its type plate.

3.3 Items supplied

Rotary hammer, side handle, depth gauge, operating instructions.

Other system products approved for use with this product can be found at your local **Hilti Store** or online at: www.hilti.group | USA: www.hilti.com.

4 Technical data



Note

For details of the rated voltage, current, frequency and/or input power, please refer to the power tool's country-specific type identification plate.

When powered by a generator or transformer, the generator or transformer's power output must be at least twice the rated input power shown on the rating plate of the power tool. The operating voltage of the transformer or generator must always be within +5% and -15% of the rated voltage of the power tool.

	TE 7
Weight in accordance with EPTA procedure 01	2.9 kg
Ø Hammer drill bits	4 mm ...24 mm
Ø Drill bits for wood	5 mm ...20 mm
Ø Drill bits for metal	5 mm ...13 mm

4.1 Noise information and vibration values in accordance with EN 60745

The sound pressure and vibration values given in these instructions have been measured in accordance with a standardized test and may be used to compare one power tool with another. They may be used for a preliminary assessment of exposure.

The data given represents the main applications of the power tool. However, if the power tool is used for different applications, with different accessory tools or is poorly maintained, the data may vary. This may significantly increase exposure over the total working period.

An accurate estimation of exposure should also take into account the times when the power tool is switched off, or when it is running but not actually being used for a job. This may significantly reduce exposure over the total working period.

Identify additional safety measures to protect the operator from the effects of noise and/or vibration, for example: Maintaining the power tool and accessory tools, keeping the hands warm, organization of work patterns.

Noise emission values

Sound (power) level (L_{WA})	100 dB(A)
Uncertainty for the sound power level (K_{WA})	3 dB(A)
Emission sound pressure level (L_{pA})	89 dB(A)
Uncertainty for the sound pressure level (K_{pA})	3 dB(A)

Total vibration

Drilling in metal ($a_{h, HD}$)	4.5 m/s ²
Hammer drilling in concrete ($a_{h, HD}$)	11 m/s ²
Uncertainty for the given vibration value (K)	1.5 m/s ²

5 Operation

5.1 Fitting the side handle



CAUTION

Risk of injury! The depth gauge, if fitted but not used, might hinder the operator.

- ▶ Remove the depth gauge from the tool.



CAUTION

Risk of injury! Loss of control over the rotary hammer drill.

- ▶ Check that the side handle is fitted correctly and tightened securely. Check that the clamping band is engaged in the groove in the tool.

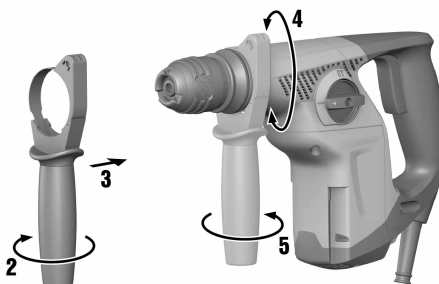

- ▶ Fit the side handle.

5.2 Fitting / removing the chuck



CAUTION

Risk of injury! The depth gauge, if fitted but not used, might hinder the operator.

- ▶ Remove the depth gauge from the tool.

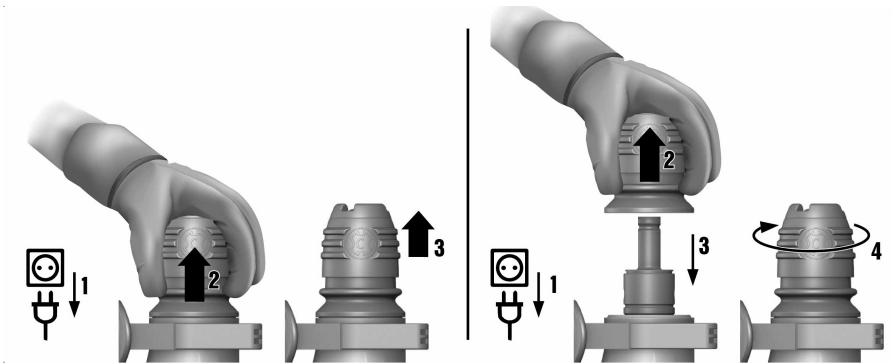

► Fit / remove the chuck.

5.3 Fitting / removing the accessory tool



Note

Use of unsuitable grease may cause damage to the product. **Use only the recommended grease supplied by Hilti.**

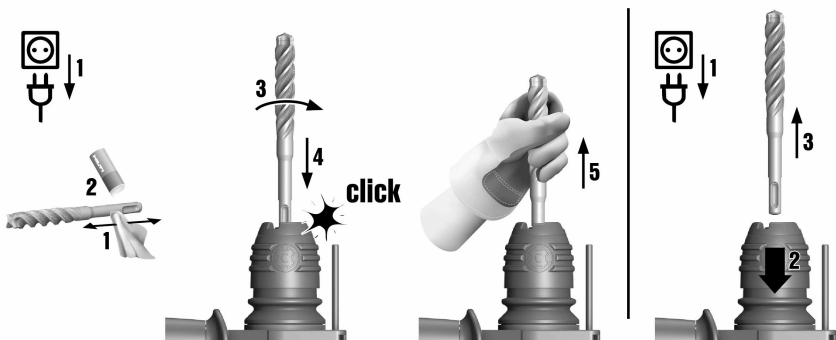

► Fit the accessory tool or, respectively, remove it.

5.4 Adjusting the depth gauge

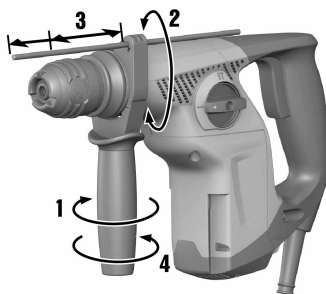

► Adjust the depth gauge.

5.5 Drilling without hammering



- ▶ Set the function selector switch to the "Drilling without hammering" position.

5.6 Drilling with hammering action (hammer drilling)

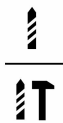

- ▶ Set the function selector switch to the "Hammer drilling" position.

5.7 Forward / reverse



- ▶ Set the forward / reverse selector switch to forward or reverse rotation.

6 Care and maintenance



WARNING

Danger of electric shock! Carrying out care and maintenance while the supply cord is connected to the power outlet presents a risk of serious injuries including burns.

- ▶ Always unplug the supply cord before carrying out all care and maintenance tasks.

Care

- Carefully remove stubborn dirt from the tool.
- Clean the air vents carefully with a dry brush.
- Use only a slightly damp cloth to clean the casing. Do not use cleaning agents containing silicone as they can attack the plastic parts.

Maintenance



WARNING

Danger of electric shock! Improper repairs to electrical components may lead to serious injuries including burns.

- ▶ Repairs to the electrical section of the tool or appliance may be carried out only by trained electrical specialists.
- At regular intervals, check all visible parts and the controls for signs of damage and make sure that they all function correctly.
- Do not operate the power tool if signs of damage are found or if parts malfunction. Have damage repaired immediately by Hilti Service.
- After cleaning and maintenance, refit all guards or protective devices and check that they function correctly.

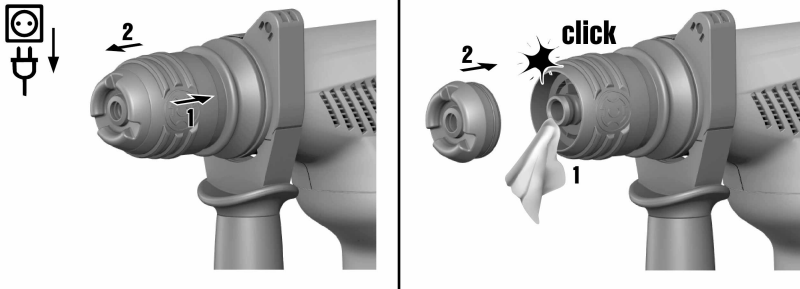

6.1 Replacing the dust shield





- ▶ Replace the dust shield.

7 Troubleshooting

Trouble or fault	Possible cause	Action to be taken
The power tool doesn't start.	Interruption in the electric supply.	▶ Plug in another electric tool or appliance and check whether it works.
No hammering action.	The power tool is too cold.	▶ Bring the tip of the drill bit into contact with the working surface, switch the rotary hammer on and allow it to run. If necessary, repeat the procedure until the hammering mechanism begins to operate.

Trouble or fault	Possible cause	Action to be taken
No hammering action.	The function selector switch is set to "Drilling without hammering"  .	▶ Set the function selector switch to  (drilling with hammering action, i.e. hammer drilling).
The rotary hammer doesn't achieve full power.	The gauge (cross section) of the extension cord conductors is inadequate.	▶ Use an extension cord with an adequate conductor cross section.
	The control switch is not fully pressed.	▶ Press the control switch as far as it will go.
The drill bit cannot be released.	The chuck is not pulled back fully.	▶ Pull the chuck back as far as it will go and remove the accessory tool.
The drill bit makes no progress.	The power tool has been set to reverse rotation.	▶ Set the power tool to forward rotation.

7.1 Troubleshooting

Trouble or fault	Possible cause	Action to be taken
The power tool doesn't start.	Interruption in the electric supply.	▶ Plug in another electric tool or appliance and check whether it works.
No hammering action.	The power tool is too cold.	▶ Bring the tip of the drill bit into contact with the working surface, switch the rotary hammer on and allow it to run. If necessary, repeat the procedure until the hammering mechanism begins to operate.
	The function selector switch is set to "Drilling without hammering"  .	▶ Set the function selector switch to  (drilling with hammering action, i.e. hammer drilling).
The rotary hammer doesn't achieve full power.	The gauge (cross section) of the extension cord conductors is inadequate.	▶ Use an extension cord with an adequate conductor cross section.
	The control switch is not fully pressed.	▶ Press the control switch as far as it will go.
The drill bit cannot be released.	The chuck is not pulled back fully.	▶ Pull the chuck back as far as it will go and remove the accessory tool.
The drill bit makes no progress.	The power tool has been set to reverse rotation.	▶ Set the power tool to forward rotation.

8 Disposal

 Most of the materials from which **Hilti** tools and appliances are manufactured can be recycled. The materials must be correctly separated before they can be recycled. In many countries, your old tools, machines or appliances can be returned to **Hilti** for recycling. Ask **Hilti** Service or your Hilti representative for further information.



- ▶ Disposal of electric tools or appliances together with household waste is not permissible.

9 RoHS (Restriction of Hazardous Substances)

Click on the link to go to the table of hazardous substances: qr.hilti.com/r4695.

There is a link to the RoHS table, in the form of a QR code, at the end of this document.

10 Manufacturer's warranty

- ▶ Please contact your local **Hilti** representative if you have questions about the warranty conditions.



Hilti Aktiengesellschaft
Feldkircherstraße 100
9494 Schaan | Liechtenstein

TE 7 (02)

[2010]

2006/42/EG

EN ISO 12100

2011/65/EU

EN 60745- 1

2014/30/EU

EN 60745-2-6

Schaan, 05/2015

Paolo Luccini

Head of BA Quality and
Process-Management
BA Electric Tools & Accessories

Tassilo Deinzer

Executive Vice President
BU Electric Tools & Accessories





Hilti Corporation

LI-9494 Schaan

Tel.: +423/234 21 11

Fax: +423/234 29 65

www.hilti.group

Hilti = registered trademark of Hilti Corp., Schaan



20170928