

HUS 6 Screw anchor

	Anchor version	Benefits
	HUS 6	- Quick and easy setting - Low expansion forces in base materials - Through fastening - Removable - Forged-on washer and hexagon head with no protruding thread
	HUS-S 6	
	HUS-H 6	
	HUS-A 6	



Concrete



Redundant fastening



Solid brick



Hollow brick



Autoclaved aerated concrete



Fire resistance



Small edge distance and spacing

Approvals / certificates

Description	Authority / Laboratory	No. / date of issue
Allgemeine bauaufsichtliche Zulassung (national approval in Germany) ^{a)}	DIBt, Berlin	Z-21.1-1710 / 2009-05-20
Fire test report	IBMB, Braunschweig DIBt, Berlin	UB 3574/5146 / 2006-05-20 Z-21.1-1710 / 2009-05-20
Assessment report (fire)	warringtonfire	WF 166402 / 2007-10-26

a) The data given in this section for HUS 6, HUS-H 6 and HUS-A 6 in cracked concrete (redundant fastening) according Z-21.1-1710, issue 2009-05-20.

Basic loading data

All data in this section applies to

- Correct setting (See setting instruction)
- No edge distance and spacing influence
- Concrete as specified in the table
- Steel failure
- Concrete C 20/25, $f_{ck,cube} = 25 \text{ N/mm}^2$

Note:

- When tightening the screw anchor in soft base materials and in hollow brick, care must be taken not to apply too much torque. If the screw anchor is over-tightened the fastening point is unusable for the HUS 6

All data on this sections applies to

- Solid masonry units:
 - Mz 12 → solid brick, compressive strength 12N/mm^2 , bulk density $1,8\text{N/mm}^2$, format $\geq 240/175/113 \text{ mm}$ (length/width/height)
 - KS 12 → solid lime block, compressive strength 12N/mm^2 , bulk density $2,0\text{N/mm}^2$, format $\geq 240/175/113 \text{ mm}$ (length/width/height)

The core/material ratio in bricks and solid sand lime blocks may not exceed 15% of a bed joint area.

- Autoclaved aerated concrete:
 - PB6 → block, compressive strength 6 N/mm², bulk density 0,6 N/mm²
 - PB2 → block, compressive strength 2 N/mm², bulk density 0,2 N/mm²
- Other Limits:
 - Applied loads to individual bricks/blocks without compression may not exceed 1,0 kN
 - Applied loads to individual bricks/blocks with compression may not exceed 1,4 kN
 - Data applies only to bricks/blocks, there is no test data available for loads in mortar joints. Hilti recommends at least a 50% load reduction or on site testing, if the location of the anchor in relation to the joint (see drawing) can not be specified because of wall plaster or insulation.
 - Plaster, gravelling, lining or levelling courses are regarded as non-bearing and may not be taken into account for calculation of embedment depth.
 - All data is for redundant fastening for non structural applications.

Recommended loads

	concrete C20/25		MZ 20 solid brick ^{b)}	KS sand Lime Block ^{b)}	Hz 0.8/12 Hollow Brick ^{b)}	Aerated concrete							
	Non-cracked	Cracked ^{a)}				PB2 / PB4 ^{c)}	PB6						
Anchor size	HUS 6		HUS 6	HUS 6	HUS 6	HUS 6		HUS 6					
h_{nom} [mm]	34		44	44	64	64		64					
Edge distance $c \geq$ [mm]	60	30	100	60	30	60	30	60	30				
Tensile $N_{rec}^{d)}$ [kN]	1,0	1,0	0,5	0,2	0,2	1,0	1,0	0,1	0,1	0,2	0,2	0,2	0,2
Shear $V_{rec}^{d)}$ [kN]	1,6	0,5	0,5	0,4	0,3	1,1	0,4	0,4	0,2	0,3	0,1	0,6	0,2

a) Redundant fastening

b) Holes must be drilled using rotary action only (no hammering action)

c) No anchor hole drilling required in PB2/PB4 gas aerated concrete

d) With overall partial safety factor for action $\gamma = 1.4$. The partial safety factors for action depend on the type of loading and shall be taken from national regulations.

Materials

Mechanical properties

Anchor size	HUS 6	HUS-H 6	HUS-A 6	HUS-S 6
Nominal tensile strength f_{uk} [N/mm ²]	1000	1000	1000	1000
Yield strength f_{yk} [N/mm ²]	900	900	900	900
Stressed cross-section A_s [mm ²]	5,2	5,2	5,2	5,2
Moment of resistance W [mm ³]	13,8	13,8	13,8	13,8
Design bending resistance $M_{Rd,s}$ [Nm]	11	11	11	11

Material quality

Part	Material
Screw anchor	Carbon Steel, galvanised to min. 5 μ m

Anchor dimensions

Dimensions

Anchor version	l_s [mm]	d_k [mm]	d [mm]	d_G [mm]	l_G [mm]
HUS 6	35..220	5,3	7,5	-	-
HUS-H 6	35..120		7,5	-	-
HUS-S 6	100..220		7,5	-	-
HUS-A 6 x 45-M8/lg	45		7,5	M8	18
HUS-A 6 x 65-M8/lg	65				
HUS-A 6 x 45-M10/lg	45				
HUS-A 6 x 65-M10/lg	65				

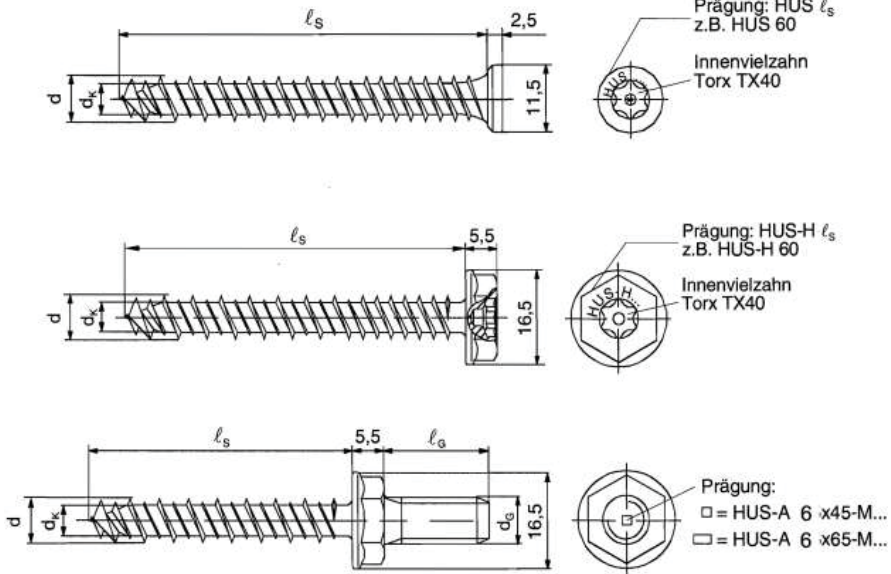

Setting

Recommended installation equipment

Anchor size	HUS 6	HUS-H 6	HUS-A 6	HUS-S 6
Rotary hammer	TE 6 / TE 7			
Drill bit	TE-C3X 6/17			
Recommended Setting Tool	SID/SIW 121, SID/SIW 144, TKI 2500			
Accessories	S-B TXI 40 bit	S-NSD 13 1/2 socket or S-B TXI 40 bit	S-NS 13 L Socket	S-B TXI 30 bit

Setting instruction

HUS:

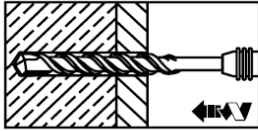

Drill hole with drill bit.

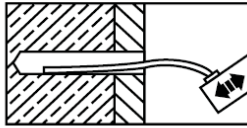

Blow out dust and fragments.

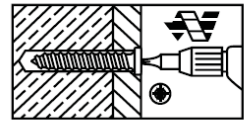

Install anchor with an electric screwdriver.

HUS-S:

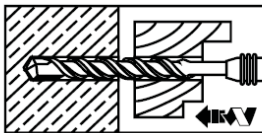

Drill hole with drill bit.

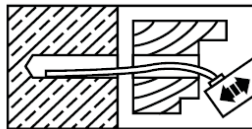

Blow out dust and fragments.

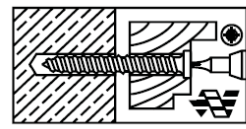

Install anchor with an electric screwdriver.

HUS-H:

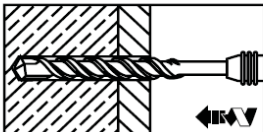

Drill hole with drill bit.

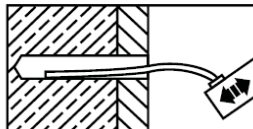

Blow out dust and fragments.

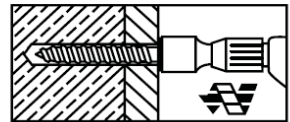

Install anchor with an electric screwdriver.

HUS-A:

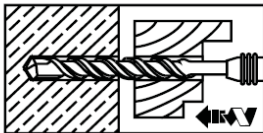

Drill hole with drill bit.

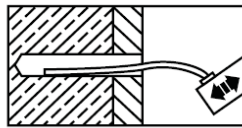

Blow out dust and fragments.

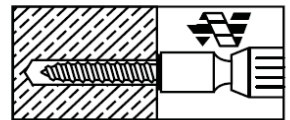

Install anchor with an electric screwdriver.

For detailed information on installation see instruction for use given with the package of the product.

Setting details: depth of drill hole h_1 and effective anchorage depth h_{ef}

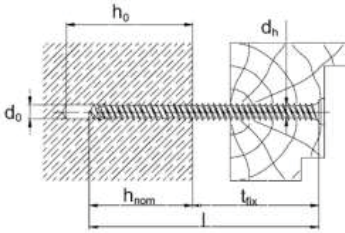

HUS

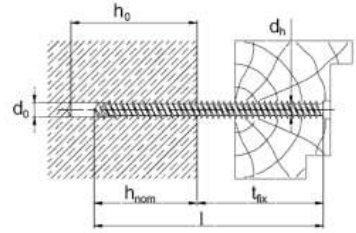

HUS-S

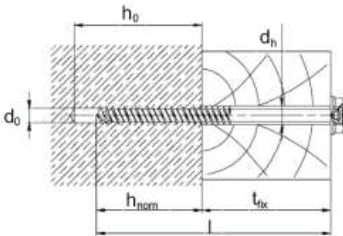

HUS-H

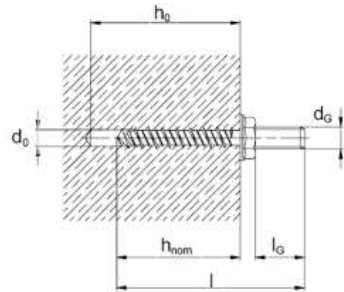

HUS-A

Setting details

Anchor version	HUS-H	C20/25 Concrete	MZ 20 Brick/ KS 12 Block	Hollow Brick	Aerated Concrete	
					PB2/PB4	PB6
Nominal embedment depth	h_{nom} [mm]	34	44	64	64	64
Nominal diameter of drill bit	d_0 [mm]	6	6	6	-	6
Cutting diameter of drill bit	$d_{cut} \leq$ [mm]	6,4	6,4	6,4	-	6,4
Minimum depth of drill hole	$h_1 \geq$ [mm]	50	54 ^{b)}	64 ^{a)}	- ^{b)}	70
Diameter of clearance hole in the fixture to clamp a fixture	$d_f \leq$ [mm]	8,5				
Diameter of clearance hole in the fixture for stand-off applications	$d_f \leq$ [mm]	6,2				
Max. fastening thickness	t_{fix} [mm]	$l_s - h_{nom}$				
Max. installation torque	T_{inst} [Nm]	10	4	2	2	2

a) Holes must be drilled using rotary action only (no hammering action)

b) No anchor hole drilling required in PB2/PB4 gas aerated concrete

Permissible anchor location in brick and block walls

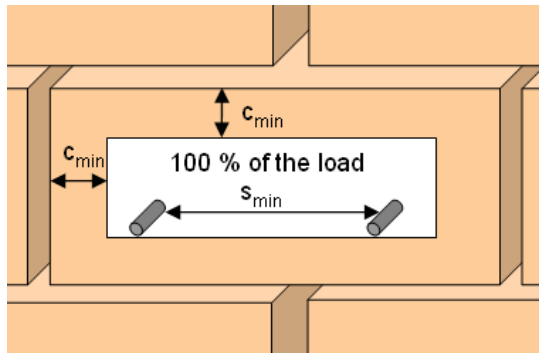

- Distance to free edge free edge to solid masonry (Mz and KS) units ≥ 200 mm
- Distance to free edge free edge to solid masonry (HLz and autoclaved aerated gas concrete) units ≥ 170 mm
- The minimum distance to horizontal and vertical mortar joint (c_{min}) is stated in the recommended load table.
- Data applies only to bricks/blocks, there is no test data available for loads in mortar joints. Hilti recommends at least a 50% load reduction or on site testing, if the location of the anchor in relation to the joint (see drawing) can not be specified because of wall plaster or insulation.
- Minimum anchor spacing (s_{min}) in one brick/block is $\geq 2 \cdot c_{min}$