



Hilti X-C B3 MX Concrete Nails with BX 3

Submission Folder

Product Information

Battery-actuated fastening tool BX 3-L 02	2
Nails and accessories for BX 3-L 02	3
Battery-actuated fastening tool BX 3-L ME 02	4
Accessories for BX 3-L ME 02	5

Technical Information	8
-----------------------	---

Letters

Country of Origin	18
-------------------	----

Job Reference	20
---------------	----



Recycling one ton of paper saves 17 trees and 7000 gallons of water.
Please consider your environmental responsibility before using the hard copy version!

Battery-actuated fastening tool BX 3-L 02



APPLICATIONS

- Fastening drywall track to floors, walls and ceilings on concrete, solid masonry or steel
- Fastening mesh, membranes or foil with special washer holders to concrete walls
- Fastening wall tie connections to concrete, solid masonry or steel – use of the special washer holder is recommended
- Suitable for various light-duty fastening applications on concrete, solid masonry or steel
- Fastening cables, conduits or various light electrical installations – use of the ME nailer nose is recommended
- Fastening wood up to 25 mm thick to concrete

ADVANTAGES

- Combustion-free operation – no gas cans or powder cartridges to store and dispose of
- Drives up to 800/500/400 fasteners with a single battery charge (depending on B22 battery model - 5.2 Ah, 3.0 Ah or 2.6 Ah)
- Engineered for high productivity – fastening rate of 1.3 nails per second
- Slim design for easier access in corners, close to walls or in tight spaces
- Cordless tool platform – the same battery for all 22V Hilti tools



Technical data	
Power (max.)	85 J
Weight	3.48 kg
Automatic piston return	Yes
Emission noise-pressure level at the work station: LpA, 1s ¹⁾	90 dB (A)
Dimensions (LxWxH)	474 x 134 x 368 mm
Max. fastener driving rate	650
Weight according to EPTA Procedure 01/2003	4 kg
Fastener intake	30 nails
Fastener length range	14 - 36 mm

¹⁾ Declared measured values of noise characteristics according to 2006/42/EC Machinery Directive in conjunction with E DIN EN 15895

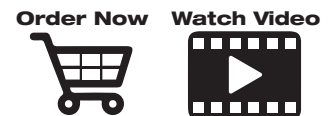

Ordering designation	Package contents	Sales pack quantity	Item number
BX 3-L 02	1x Battery-actuated tool BX 3-L 02, 1x Case	1 pc	2161469

Please visit Hilti website for the latest item numbers and related products

Battery and charger info

Ordering designation		Sales pack quantity	Item number
Battery quick charger C 4/36-350 110V		1 pc	2028877
Battery quick charger C 4/36-350 230V		1 pc	2028876
Battery pack B 22/2.6 Li-Ion		1 pc	2110532
Battery pack B 22/5.2 Li-Ion		1 pc	2136396

Please visit Hilti website for the latest item numbers and related products

Nail for BX 3-L 02











Order Now



Ordering designation	Fastener shank length	Fastener shank diameter	Sales pack quantity	Item number
X-C 20 B3 MX	20 mm	3 mm	1000 pc	2123993
X-C 24 B3 MX	24 mm	3 mm	1000 pc	2123994
X-C 30 B3 MX	30 mm	3 mm	1000 pc	2149988
X-C 36 B3 MX	36 mm	3 mm	1000 pc	2149989

Please visit Hilti website for the latest item numbers and related products



Accessories for BX 3-L 02

Ordering designation		Sales pack quantity	Item number
Washer R23-0.6 Eco		1000 pc	407950
Washer R36-0.6 Eco		1000 pc	407951
Washer holder X-WH B3 02 packed		1 pc	2179277
Fastener guide X-FG B3-ME 02 packed		1 pc	2179276
Fastener guide X-FG B3-IF 02 packed		1 pc	2179275
Pole Tool X-PT 7ft for BX 3		1 pc	3579450
Receptacle X-PT B3		1 pc	2101255
Brace X-SL B3 packed		1 pc	2101257 ¹⁾
Safety glasses PP EY-CA NCH clear		1 pc	2065449 ¹⁾

¹⁾For detailed stock availability and lead time information please contact your Hilti representative.

Please visit Hilti website for the latest item numbers and related products

Accessories for BX 3

Ordering designation		Sales pack quantity	Item number
Washer holder X-WH B3 packed		1 pc	2101256
Fastener guide X-FG B3-ME packed		1 pc	2101258
Fastener guide X-FG B3-IF packed		1 pc	2116415

Please visit Hilti website for the latest item numbers and related products

Battery-actuated fastening tool BX 3-L ME 02



APPLICATIONS

- Fastening drywall track to floors, walls and ceilings on concrete, solid masonry or steel
- Fastening mesh, membranes or foil with special washer holders to concrete walls
- Fastening wall tie connections to concrete, solid masonry or steel – use of the special washer holder is recommended
- Suitable for various light-duty fastening applications on concrete, solid masonry or steel
- Fastening cables, conduits or various light electrical installations – use of the ME nailer nose is recommended
- Fastening wood up to 25 mm thick to concrete

ADVANTAGES

- Combustion-free operation – no gas cans or powder cartridges to store and dispose of
- Drives up to 800/500/400 fasteners with a single battery charge (depending on B22 battery model - 5.2 Ah, 3.0 Ah or 2.6 Ah)
- Engineered for high productivity – fastening rate of 1.3 nails per second
- Slim design for easier access in corners, close to walls or in tight spaces
- Cordless tool platform – the same battery for all 22V Hilti tools



Fleet Management

Technical data

Power (max.)	85 J
Weight	3.48 kg
Automatic piston return	Yes
Emission noise-pressure level at the work station: LpA, 1s ¹⁾	90 dB (A)
Dimensions (LxWxH)	474 x 134 x 368 mm
Max. fastener driving rate	650
Weight according to EPTA Procedure 01/2003	4 kg
Fastener intake	30 nails
Fastener length range	14 - 36 mm

¹⁾ Declared measured values of noise characteristics according to 2006/42/EC Machinery Directive in conjunction with E DIN EN 15895



Order Now



Watch Video



Ordering designation	Package contents	Sales pack quantity	Item number
BX 3-L 02 with X-FG ME	1x Battery-actuated tool BX 3-L 02, 1x Fastener guide X-FG B3-ME packed, 1x case	1 pc	3611127

Please visit Hilti website for the latest item numbers and related products

Battery and charger info

Ordering designation		Sales pack quantity	Item number
Battery quick charger C 4/36-350 110V		1 pc	2028877
Battery quick charger C 4/36-350 230V		1 pc	2028876
Battery pack B 22/2.6 Li-Ion		1 pc	2110532
Battery pack B 22/5.2 Li-Ion		1 pc	2136396

Please visit Hilti website for the latest item numbers and related products

Fasteners for Electrical and Mechanical Applications

Cable tie holders X-ECT MX



Order Now



Ordering designation	Max wide	Sales pack quantity	Item number
X-ECT MX	9 mm	100 pc	285709 ¹⁾
X-ECT UV MX	9 mm	100 pc	285710 ¹⁾

¹⁾ For detailed stock availability and lead time information please contact your Hilti representative.

Please visit Hilti website for the latest item numbers and related products

Cable clasps X-EKB MX



Order Now



Ordering designation	Cable capacity (8mm cable)	Sales pack quantity	Item number
X-EKB 4 MX	4	100 pc	285712 ¹⁾
X-EKB 8 MX	8	100 pc	285713 ¹⁾
X-EKB 16 MX	16	25 pc	285714 ¹⁾

¹⁾ For detailed stock availability and lead time information please contact your Hilti representative.

Please visit Hilti website for the latest item numbers and related products

Bunched-Cable holders X-ECH MX



Order Now



Ordering designation	Cable capacity (8mm cable)	Sales pack quantity	Item number
X-ECH 15/B MX kit	15	100 pc	2018729 ¹⁾
X-ECH 30/B MX kit	30	50 pc	2018891 ¹⁾
Base X-ECH-B MX	-	50 pc	2018391 ¹⁾

¹⁾ For detailed stock availability and lead time information please contact your Hilti representative.

Please visit Hilti website for the latest item numbers and related products

Cable trunking fastener X-ET MX



Order Now



Ordering designation	Sales pack quantity	Item number
X-ET MX	250 pc	285718

Please visit Hilti website for the latest item numbers and related products

Customer Hotline: Hong Kong 8228 8118, Macau 00800 8228 8118 Email: hksales@hilti.com

Conduit clamps X-EKS MX



Order designation	Cable conduit diameter	Sales pack quantity	Item number
X-EKS 16 MX	16 mm	100 pc	285719 ¹⁾
X-EKS 20 MX	20 mm	100 pc	285720
X-EKS 25 MX	25 mm	100 pc	285721
X-EKS 32 MX	32 mm	100 pc	285722 ¹⁾

¹⁾ For detailed stock availability and lead time information please contact your Hilti representative.

Please visit Hilti website for the latest item numbers and related products

Snap-lock conduit clamps X-EKSC MX



Order designation	Cable conduit diameter	Sales pack quantity	Item number
X-EKSC 20 MX	20 mm	100 pc	274086 ¹⁾
X-EKSC 25 MX	20 mm	100 pc	274087 ¹⁾

¹⁾ For detailed stock availability and lead time information please contact your Hilti representative.

Please visit Hilti website for the latest item numbers and related products

Metal conduit clamps X-EMTSC MX



Order designation	Sales pack quantity	Item number
X-EMTSC 1/2" MX	100 pc	228338 ¹⁾
X-EMTSC 3/4" MX	100 pc	228339 ¹⁾
X-EMTSC 1" MX	100 pc	228340 ¹⁾

¹⁾ For detailed stock availability and lead time information please contact your Hilti representative.

Please visit Hilti website for the latest item numbers and related products

Metal conduit clip X-FB MX



Order designation	Cable conduit diameter	Sales pack quantity	Item number
X-FB 16 MX	16 mm	200 pc	286799 ¹⁾
X-FB 20 MX	20 mm	200 pc	286800
X-FB 25 MX	25 mm	200 pc	286802
X-FB 32 MX	32 mm	100 pc	286804 ¹⁾

¹⁾ For detailed stock availability and lead time information please contact your Hilti representative.

Please visit Hilti website for the latest item numbers and related products

Butterfly metal conduit clip X-DFB MX



Order Now



Order designation	Cable conduit diameter	Sales pack quantity	Item number
X-DFB 20 MX	20 mm	100 pc	273384 ¹⁾
X-DFB 25 MX	20 mm	100 pc	273386 ¹⁾

¹⁾ For detailed stock availability and lead time information please contact your Hilti representative.

Please visit Hilti website for the latest item numbers and related products

Threaded rod hanger X-EHS M MX



Order Now



Order designation	Sales pack quantity	Item number
X-EHS M8 MX	100 pc	273368 ¹⁾

¹⁾ For detailed stock availability and lead time information please contact your Hilti representative.

Please visit Hilti website for the latest item numbers and related products

Ceiling clip X-ECC MX



Order Now



Order designation	Sales pack quantity	Item number
X-ECC MX	100 pc	228342

Please visit Hilti website for the latest item numbers and related products

BX 3 System Fastener for interior finishing, building construction, mechanical and electrical application

Product data

BX 3 battery-actuated direct fastening tools



BX 3-ME (02)
BX 3-IF



BX 3 02
BX 3-L 02

Features and benefits

- Hilti's combustion-free direct fastening technology for driving nails into concrete, steel and some types of solid masonry
- High user comfort thanks to low levels of compression force, noise and recoil
- No disposal of (used) propellant cartridges or gas cans
- Hilti's 22V cordless tool battery platform

Fasteners and their compatibility

Nails

For fastening to concrete

- X-P 17/20/24 B3 MX
- X-P 30/36 B3 P7
- X-C 20/24/27/30 B3 MX

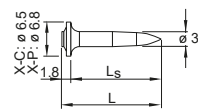

X-C 36 B3 MX

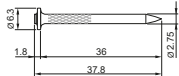

For fastening to steel

- X-S 14 B3 MX

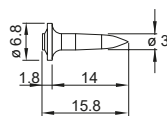

Threaded studs

For fastening to concrete

- X-M6-7-24 B3 P7

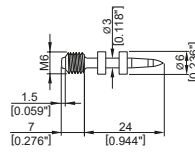

X-W6-12-20 B3 P7

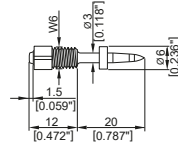

For fastening to steel

- X-M6-7-14 B3 P7

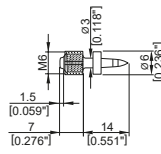

X-W6-12-14 B3 P7

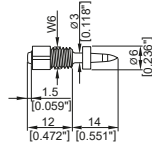

	BX 3-ME (02)	BX 3-IF	BX 3 02	BX 3-L 02
X-S 14 B3 MX	yes	yes	yes	yes
X-P 17 B3 MX	yes	yes	yes	yes
X-P 20 B3 MX	yes	yes	yes	yes
X-P 24 B3 MX	yes	yes	yes	yes
X-C 20 B3 MX	yes	yes	yes	yes
X-C 24 B3 MX	yes	yes	yes	yes
X-C 27 B3 MX	no	no	yes	yes
X-C 30 B3 MX	no	no	yes	yes
X-C 36 B3 MX	no	no	no	yes
X-M/W _ _ _ B3 P7	yes	yes	no	no
X-P _ B3 P7	yes	yes	no	no
ME MX elements	yes	with ME FG	with ME FG	with ME FG

General information

Material specifications

- X-P B3 MX/P7, X-S B3 MX
- X-C B3 MX

Carbon steel, HRC 57.5, 2-13 µm zinc coating
Carbon steel, HRC 56.5, 2-13 µm zinc coating

Electrical elements to be used with nails - examples

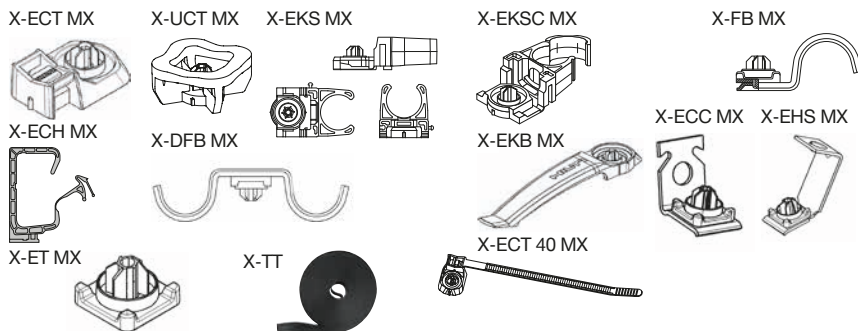

General information

Material specifications

X-ECT MX, X-EKS, X-EKSC MX, ECH MX
 X-EKB MX
 X-ECT-FR MX
 X-EKB-FR MX
 X-UCT MX, X-ET MX
 X-TT
 X-FB MX, X-DFB MX
 X-ECC MX, X-EHS MX

PA, halogen free, silicone free, light grey RAL 7035

PA, halogen free, light grey RAL 7035

PBT, silicone free, flame retardant, stone grey RAL 7030

PBT, silicone free, flame retardant, stone grey RAL 7030

HDPE, halogen free, silicone free, light grey RAL 7035

PET

Galvanized steel sheet, $f_u = 270-420 \text{ N/mm}^2$, 10–20 μm zinc coating

Galvanized steel sheet, $f_u = 270-420 \text{ N/mm}^2$, 10–20 μm zinc coating

Approvals

ICC-ESR 1752 (USA)
 ETA-16/0301

X-P 20 B3 MX, X-P 24 B3 MX, various electrical elements (see ETA approval Annex A1)

Applications

With nails



Drywall tracks to concrete and steel



Fastening wood, e.g. Placopan®, to concrete



Junction boxes, switch boxes, etc

With nails and elements



Flexible or rigid cable conduits with cable ties



Fastening cables



Cable conduits or light-duty pipes

Performance data

Performance data for drywall track fastening

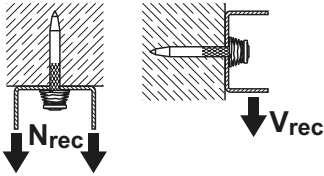

X-S 14 B3 MX (Base material: steel)

Tension N_{rec} [kN]	Shear V_{rec} [kN]
0.4	0.4

X-P B3, X-C B3 (Base material: concrete / sand-lime masonry)

Embedment [mm]	Recommended Loads [kN]					
	Tension N_{rec}		Shear V_{rec}		Tension N_{rec}	Shear V_{rec}
	Concrete Type				Sand-lime masonry	
	Soft	Tough	Soft	Tough		
≥ 22	-	-	-	-	0.3	0.3
≥ 18	0.2	-	0.2	-	0.2	0.2
≥ 14	0.1	0.1	0.1	0.1	0.1	0.1

Conditions:

- For safety relevant fastenings sufficient redundancy of the entire system is required; Minimum of 5 nails per fastened track. All visible setting failures must be replaced
- Sheet metal failure is not considered in recommended loads and must be assessed separately
- Soft concrete up to $f_{c,cube} = 45 \text{ N/mm}^2$ (C35/45), some tough concrete up to $f_{c,cube} = 60 \text{ N/mm}^2$ (C50/60).
- Concrete with aggregate like granite or river rock or softer, and up to 16 mm diameter



	Stick rate estimation	
	Soft Concrete	Tough concrete
X-P B3	85% - 98%	70% - 85%
X-C B3	75% - 90%	55% - 70%

- The stick rate indicates the percentage of nails that were driven correctly to carry a load. Stick rate can vary from the above values depending on job site conditions.

Performance data
Recommended loads (Threaded studs only)

Threaded stud	Recommended loads and tightening torque			Base material
	N_{rec} [kN]	V_{rec} [kN]	T_{rec} [Nm]	
X-M6-7-24 B3 P7	0.05	0.05	3.0	Concrete, sand-lime masonry
X-W6-12-20 B3 P7				
X-M6-7-14 B3 P7	0.2	0.2	3.0	Steel
X-W6-12-14 B3 P7				

Recommended loads (electrical elements used with nails)

Element	Maximum service load F_{max} [N]
X-ECT (FR) MX	40
X-UCT MX	40
X-EKS MX	11
X-EKSC MX	32
X-FB MX / X-DFB MX	20
X-ECC MX	50
X-EHS MX	80
X-EKB (FR) 4 MX	9
X-EKB (FR) 8 MX	14
X-EKB (FR) 16 MX	18
X-ECH MX	40
	Cable trunking
X-ET MX	100

Conditions:

- Spacing \leq 100 mm
- All visible failures must be replaced

Nail recommendation

For **concrete** base material

Nail types	Length [mm]	Tip	Shank Ø [mm]	Material	Hardness [HRC]	Coating [µm]
X-P B3 P7/MX	17-36	Long conical	3.0	Carbon steel	57.5	Zinc, 2-10

- Premium nails (as listed above) are recommended for use on soft and some tough concrete. For more details regarding nail classification and concrete types, please refer to **Concrete Fastener Selection** section in Hilti Direct Fastening Technology Manual (DFTM)
- X-P 17/20/24 B3 MX to be used with BX 3 02, BX 3-L 02, BX 3-ME (02) and BX 3-IF
- X-P 30/36 B3 P7 to be used with BX 3-ME (02) and BX 3-IF

For **concrete** base material

Nail types	Length [mm]	Tip	Shank Ø [mm]	Material	Hardness [HRC]	Coating [µm]
X-C B3 MX	20-30 36	Cut	3.0 2.75	Carbon steel	56.5	Zinc, 5-13

- Standard nails (as listed above) are recommended for use on soft concrete only. For more details regarding nail classification and concrete types, please refer to **Concrete Fastener Selection** section in Hilti Direct Fastening Technology Manual (DFTM)
- X-C 20/24/27/30 B3 MX to be used with BX 3 02
- X-C 20/24/27/30/36 B3 MX to be used with BX 3-L 02
- X-C 20/24 B3 MX to be used with BX 3-ME (02) and BX 3-IF

For **steel** base material

Nail types	Length [mm]	Tip	Shank Ø [mm]	Material	Hardness [HRC]	Coating [µm]
X-S 14 B3 MX	14	Long conical	3.0	Carbon steel	57.5	Zinc, 2-10

- X-S 14 B3 MX to be used with BX 3 02, BX 3-L 02, BX 3-ME (02) and BX 3-IF
- Please refer to next pages for application limits on steel base material

Application requirements

Thickness of base material

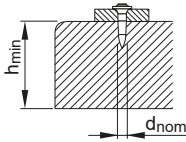

Concrete (for nails and threaded studs)
 $h_{min} = 60 \text{ mm}$
 $d_{nom} = 3.0 \text{ mm}$

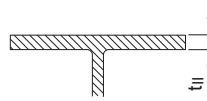

Steel
 $t_{II} \geq 4.0 \text{ mm}$ (for nails)
 $t_{II} \geq 6.0 \text{ mm}$ (for threaded studs)

Thickness of fastened material

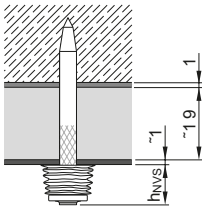

Wooden track: $t_1 \leq 27 \text{ mm}$ (conditions: head of the nail is countersunk flat to the surface)
 Metal track: $t_1 \leq 2 \text{ mm}$
 Deflection head: $t_{l.tot.} \leq 21 \text{ mm}$ (gypsum strip + metal track and sealant)

Spacing and edge distances (mm)

Max. spacing along track

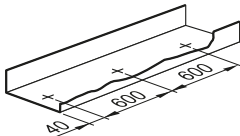

Fastener spacing max. 30 cm for proprietary light non-load-bearing partition walls with fire classification

All track ends (cut-outs for doors), secure with 2 nails

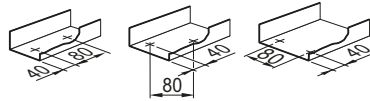

Distance to edge of concrete / sand-lime masonry

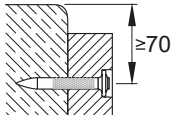

Spacing between nails when fastening wood to concrete

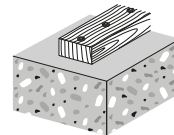
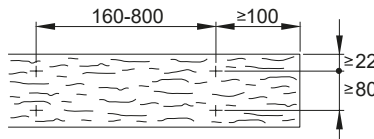

Based on common practice, spacing needs to be adjusted based on specific load requirement and achieved embedment depth.

Distance to edge of fastened material (steel base material)

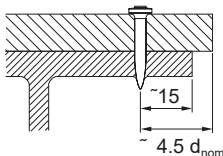

Application limits

X-S 14 B3 MX

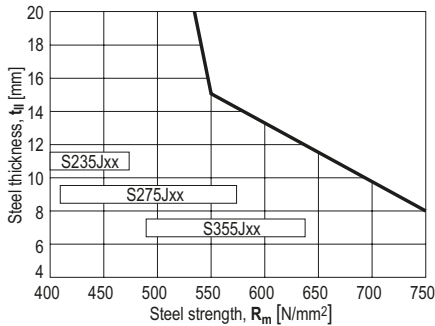

X-M6-7-14 B3 P7, X-W6-12-14 B3 P7

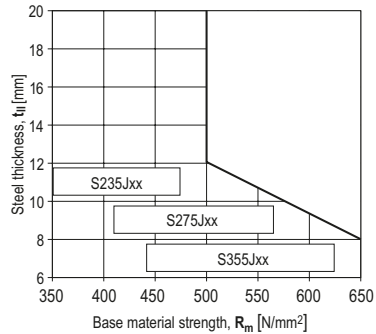

Corrosion information

The intended use only comprises fastenings which are not directly exposed to external weather conditions or moist atmospheres, i.e. only intended for dry indoor areas.

Fastener selection and system recommendation

Fastener program









Nails

Nail	Item no.	Shank length (mm)	Shank diameter (mm)	Base material	Length recommendation
X-S 14 B3 MX	2156392, 2156393	14	3	Steel	
X-P 17 B3 MX	2156216, 2156219	17	3	Concrete / Sand-lime masonry	
X-P 20 B3 MX	2156217, 2156390	20	3		
X-P 24 B3 MX	2156218, 2156391	24	3		
X-P 30 B3 P7	2105406	30	3		
X-P 36 B3 P7	2105407	36	3		
X-C 20 B3 MX	2123993	20	3		
X-C 24 B3 MX	2123994	24	3		
X-C 27 B3 MX	2224568	27	3		
X-C 30 B3 MX	2149988	30	3		
X-C 36 B3 MX	2149989	36	2.75		

Threaded studs

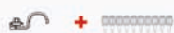
Threaded studs	Item no.	Thread size	Thread length (mm)	Shank length (mm)	Shank diameter (mm)	Base material
X-M6-7-14 B3 P7	2105408	M6	7	14	3	Steel
X-M6-7-24 B3 P7	2105409	M6	7	24	3	Concrete
X-W6-12-14 B3 P7	2105800	W6	12	14	3	Steel
X-W6-12-20 B3 P7	2105801	W6	12	20	3	Concrete

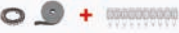
Fastener selection

	Nail Selector for BX 3-ME (02) and BX 3-IF 			
	Brick	Concrete Floor	Concrete Wall/Ceiling	Steel
	X-C 24 B3 MX	X-C 20 B3 MX X-C 24 B3 MX	X-C 20 B3 MX X-P 17 B3 MX	X-S 14 B3 MX
	-----	X-C 36 B3 P7	-----	-----
	X-C 24 B3 MX X-C 20 B3 MX		X-P 20 B3 MX	X-S 14 B3 MX
	X-P 20 B3 MX X-P 17 B3 MX	-----	X-P 17 B3 MX	X-S 14 B3 MX
	-----	X-C 24 B3 MX X-C 20 B3 MX	-----	X-S 14 B3 MX
	X-W6-12-20 B3 P7 X-M6-7-24 B3 P7			X-W6-12-14 B3 P7 X-M6-7-14 B3 P7
Propellant-free				

For more details and information, please contact your nearest Hilti representative.

Fastener selection

	Nail Selector for BX 3 02 and BX 3-L 02			
	Brick	Concrete Floor	Concrete Wall/Ceiling	Steel
	X-C 24-36 B3 MX*	X-C 20 B3 MX X-C 24 B3 MX	X-C 20 B3 MX X-P 17 B3 MX	X-S 14 B3 MX
	-----	X-C 36 B3 MX*	-----	-----
	X-C 24 B3 MX X-C 20 B3 MX		X-P 20 B3 MX	X-S 14 B3 MX
	X-P 20 B3 MX X-P 17 B3 MX	-----	X-P 17 B3 MX	X-S 14 B3 MX
	-----	X-C 24 B3 MX X-C 20 B3 MX	-----	X-S 14 B3 MX
Propellant-free				

* X-C 36 B3 MX suitable for BX 3-L 02 only

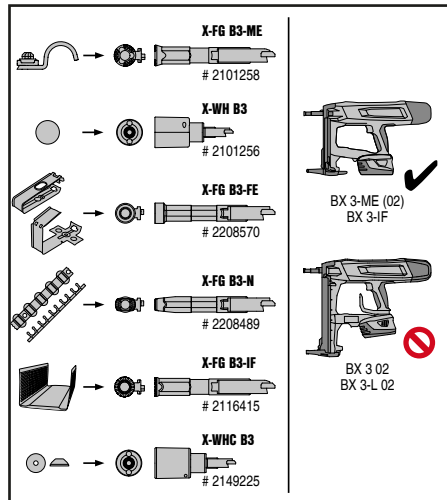
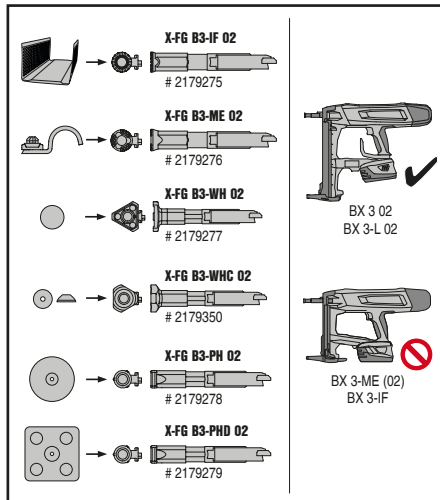

Fastening quality assurance

Fastening inspection

Nails and studs in concrete / sand-lime masonry

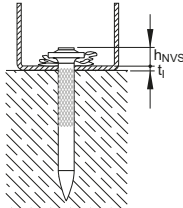

X-C_B3, X-P_B3:
 $h_{NVS} = 2-5 \text{ mm}$

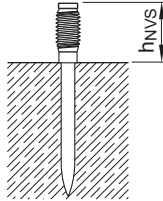

X-M6-7-24 B3 P7
X-W6-12-20 B3 P7

$h_{NVS} \geq 7 \text{ mm}$
 $\geq 12 \text{ mm}$

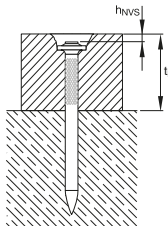

X-C_B3, X-P_B3:
 $h_{NVS} = 2-3 \text{ mm}$

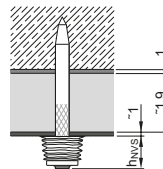

Deflection head
X-P 36 B3 P7, X-C 36 B3 MX
12.5 mm board: $h_{NVS} \leq 12 \text{ mm}$
15 mm board: $h_{NVS} \leq 9 \text{ mm}$
19 mm board: $h_{NVS} \leq 5 \text{ mm}$

Nails and studs in steel

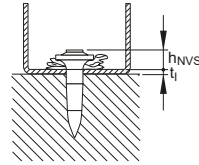

X-S_B3:
 $h_{NVS} = 2-9 \text{ mm}$

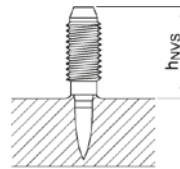

X-M6-7-14 B3 P7
X-W6-12-14 B3 P7

$h_{NVS} \geq 7 \text{ mm}$
 $\geq 12 \text{ mm}$

Element	$h_{NVS} \text{ (mm)}$	
	Concrete	Steel
X-EKB 4/8 MX	6-11	6-9
X-EKB 16 MX	6-11	6-9
X-ECT MX	6-11	6-9
X-UCT MX	6-11	6-9
X-ECH MX	6-11	6-9
X-EKS MX	6-11	6-9
X-EKSC MX	6-11	6-9
X-FB MX	7-11	7-9
X-DFB MX	7-11	7-9
X-ECC MX	7-11	7-9
X-EHS MX	7-11	7-9
X-ET MX*	5-10	5-9

*) With X-ET MX, the h_{NVS} is measured against the cable trunk.

Examples

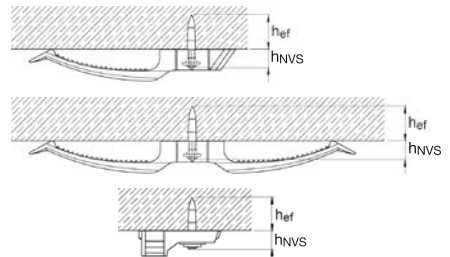

Attn. : To whom it may concern

Date : 26 September 2023
Ref. : 135/DF/DY/23

Subject : Country of Origin- Hilti X-C B3 MX Nails

Dear Sir / Madam,

Enclosed please find the information of Hilti X-C B3 MX Nails.

Brand Name : Hilti

Model Name : Hilti X-C B3 MX Nails

Manufacturer : Hilti Corporation

Address of Manufacturer : FL-9494, Principality of Liechtenstein.

Manufacturer Contact Person : Dennis Yeung

Supplier : Hilti (Hong Kong) Ltd

Address of Supplier : 701-704, 7/F, Tower A, Manulife Financial Centre,
223 Wai Yip Street, Kwun Tong, Kowloon, Hong Kong

Supplier Contact Person : Dennis Yeung (+852 9723 4621)

Country of Origin : China

Should you have further questions, please do not hesitate to contact our Technical Representatives, Customer Service Hotline at 8228-8118, or email us at hksales@hilti.com.

Yours faithfully,



Dennis Yeung
Head of Product Leadership Strategy, F&P

Attn. : To whom it may concern

Date : 26 September 2023
Ref. : 136/DF/DY/23

Subject : Country of Origin- Hilti BX 3 Battery-Actuated Fastening Tool

Dear Sir / Madam,

Enclosed please find the information of Hilti BX 3 Battery-Actuated Fastening Tool.

Brand Name : Hilti

Model Name : Hilti BX 3 Battery-Actuated Fastening Tool

Manufacturer : Hilti Corporation

Address of Manufacturer : FL-9494, Principality of Liechtenstein.

Manufacturer Contact Person : Dennis Yeung

Supplier : Hilti (Hong Kong) Ltd

Address of Supplier : 701-704, 7/F, Tower A, Manulife Financial Centre,
223 Wai Yip Street, Kwun Tong, Kowloon, Hong Kong

Supplier Contact Person : Dennis Yeung (+852 9723 4621)

Country of Origin : Austria

Should you have further questions, please do not hesitate to contact our Technical Representatives, Customer Service Hotline at 8228-8118, or email us at hksales@hilti.com.

Yours faithfully,



Dennis Yeung
Head of Product Leadership Strategy, F&P



Hilti X-C B3 MX Concrete Nails Job Reference

Year	Project Name	Customer Name	Project type
2022	HKIA 3508 TERMINAL 2	SUMMAN ENGINEERING LIMITED	Transport
2022	WAN CHAI HOPEWELL CENTRE 2	KEI IP ENGINEERING LIMITED	Hospitality
2022	R6 CTL KLN ROUTE-CENTRAL TUNNEL HY/2018/08	BOUYGUES TRAVAUX PUBLICS	Infrastructure
2022	HUNG SHUI KIU, LOT 4312 DD 124	TACTFUL BUILDING COMPANY LIMITED	Residential
2022	11 MIDDLE RD - KIMPTON HONG KONG	CR CONSTRUCTION COMPANY LIMITED	Hospitality
2022	R6 TKO-LAM TIN TUNNEL NE/2015/01	LEIGHTON - CHINA STATE JOINT	Infrastructure
2023	11 MIDDLE RD - KIMPTON HONG KONG	CR CONSTRUCTION COMPANY LIMITED	Hospitality
2023	HKIA 3508 TERMINAL 2	SUMMAN ENGINEERING LIMITED	Transport
2024	FORMER EXCELSIOR REDEVELOP - PROJECT BLUE	GAMMON ENGINEERING & CONSTRUCTION	Office
2024	11 MIDDLE RD - KIMPTON HONG KONG	CR CONSTRUCTION COMPANY LIMITED	Hospitality
2024	391 CHAI WAN RD	GOLDENWALL ENGINEERING LIMITED	Residential
2024	POLICE SCHOOL RD HKU DORM (459)	GOLDENWALL ENGINEERING LIMITED	Residential